

BÖLLHOFF

RIVKLE®

Blind rivet nuts and studs



A man with short brown hair and a goatee, wearing clear safety glasses and a blue t-shirt, is leaning over a large industrial machine in a factory. He is smiling slightly and looking towards the camera. The machine is red and blue, with various mechanical parts visible. The background shows more of the factory environment with blue structural elements.

PASSION FOR
SUCCESSFUL JOINING

	Page
General presentation of the RIVKLE® product line	
An optimized assembly solution for improved performance	4
The RIVKLE® technology	6
Setting of RIVKLE® fasteners	7
Material and surface treatment	9
Selection of the nut or stud	10
Additional services	12
Legend	13
The standard RIVKLE® line	
Blind rivet nuts	16
Blind rivet studs	35
RIVKLE® product variants	
HRT nuts - High Resistance Thread	40
SFC nuts and studs - For fiber-reinforced polymer	42
PN nuts - Ultimate pull-out force	44
Seal Ring nuts and studs and other watertight solutions	46
The RIVKLE® setting tools	
Hand operated assembly tools	50
Hydropneumatic and battery-powered setting tools	53
Special installation machines	61
BÖLLHOFF is the only supplier for your assembly components and associated tools	
Part number index	64

An optimized assembly solution for improved performance

RELIABILITY



■ **Controlled setting**

The technologies implemented in BÖLLHOFF tools allow you to make sure that 100% of the RIVKLE® fasteners are conforming after setting.

■ **Components comply with the rules applicable to threaded joints**

Obtain robust assemblies thanks to components which, after setting, are comparable to class 8 nuts (or even class 10 or 12 for HRT versions) or to class 8.8 screws (stud version).

After setting, RIVKLE® blind rivet nuts comply with the rules applicable to threaded joints. These rules guarantee, among other things, that in the case of over-tightening, the screw will fail, leaving the nut re-usable.

SIMPLICITY



■ **A safe and environmentally-friendly solution**

Reduce your environmental costs with this assembly solution which requires no exhaust or cooling.

■ **Minimal equipment and expertise required**

You can easily integrate the RIVKLE® solution into your production process, as it does not require your operators to have any particular qualifications or safety equipment.

■ **Simple to use**

The RIVKLE® technology can be integrated quickly and easily thanks to easy-to-use setting methods and simple tool adjustment procedures.



PERFORMANCE



■ **A repeatable solution**

Ensure the reliability of your assemblies by using components with a repeatable setting behavior in combination with setting tools with well-known repeatability (CPk > 1.66).

■ **A competitive global solution**

Reduce the costs of your assemblies thanks to a cost per installed RIVKLE® fastener that is usually more competitive than alternative solutions with reduced costs in manpower, energy, maintenance, investment, floor area.

VERSATILITY

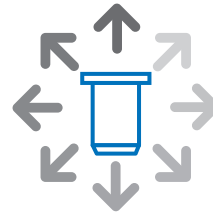

■ **RIVKLE® can be set at every stage of your production process**

You can integrate RIVKLE® at any stage of your production process, either before or after surface coating. In fact, the RIVKLE® components are supplied with a surface treatment which complies with the strictest customer requirements, and the setting operation does not alter the support or the component's surface treatment.

Moreover, as the RIVKLE® components can be set either with hand tools or with automatic setting units on robots, the RIVKLE® technology can fit into all your production environments.

■ **Compatibility with all application materials**

The RIVKLE® components are compatible with metal (steel, light alloys) as well as polymers (composites, plastics, etc.).

■ **Installation with access from only one side**

Simplify your design and integrate RIVKLE® into many of your applications, as these fasteners can be installed with access on only one side.

The dimensions and the accessibility of your parts do not hinder the use of the RIVKLE® solution.



The RIVKLE® technology

RIVKLE® blind rivet nuts and studs are the most versatile solutions to add reusable high-strength male or female threads to low thickness application materials.

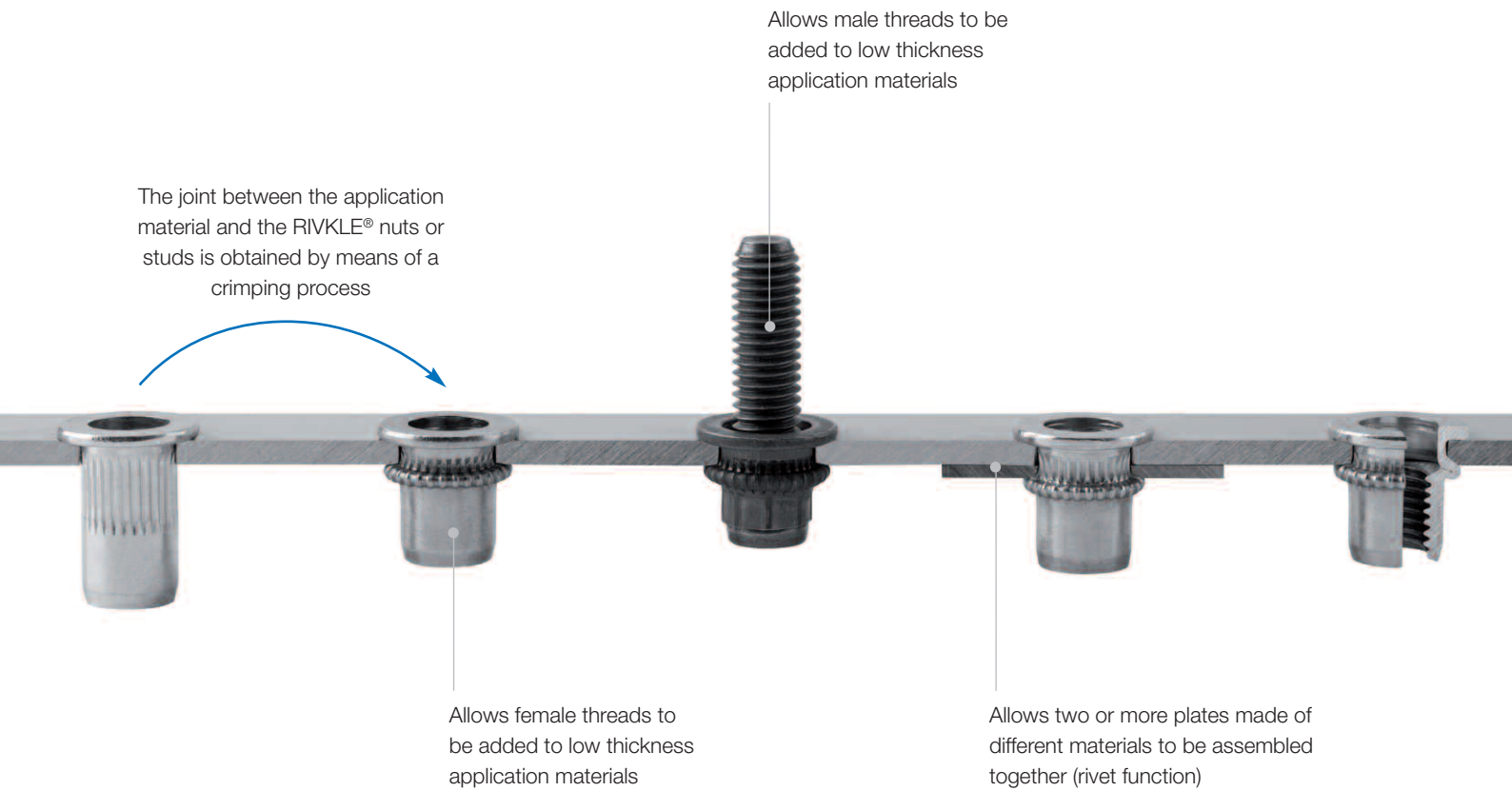

Under normal conditions of use

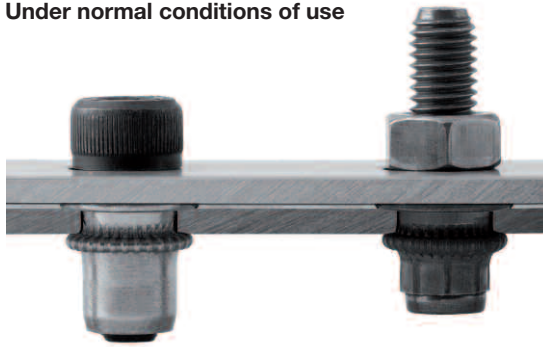

Thin head

To optimise the protrusion of thin heads after setting and ensure optimum penetration strength, BÖLLHOFF decided to use the extra-flat heads already implemented in most of the steel or stainless steel thin-head fasteners.

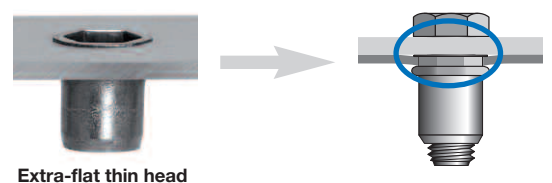

Extra-flat thin head

Setting of **RIVKLE®** fasteners

Pull setting method

The BÖLLHOFF setting tools use the pull setting method to set the RIVKLE® assembly components.

This method consists of 4 steps

- 1 (or 2) Spin on
- 2 (or 1) Insertion of the component into the support
- 3 Upset
- 4 Spin off

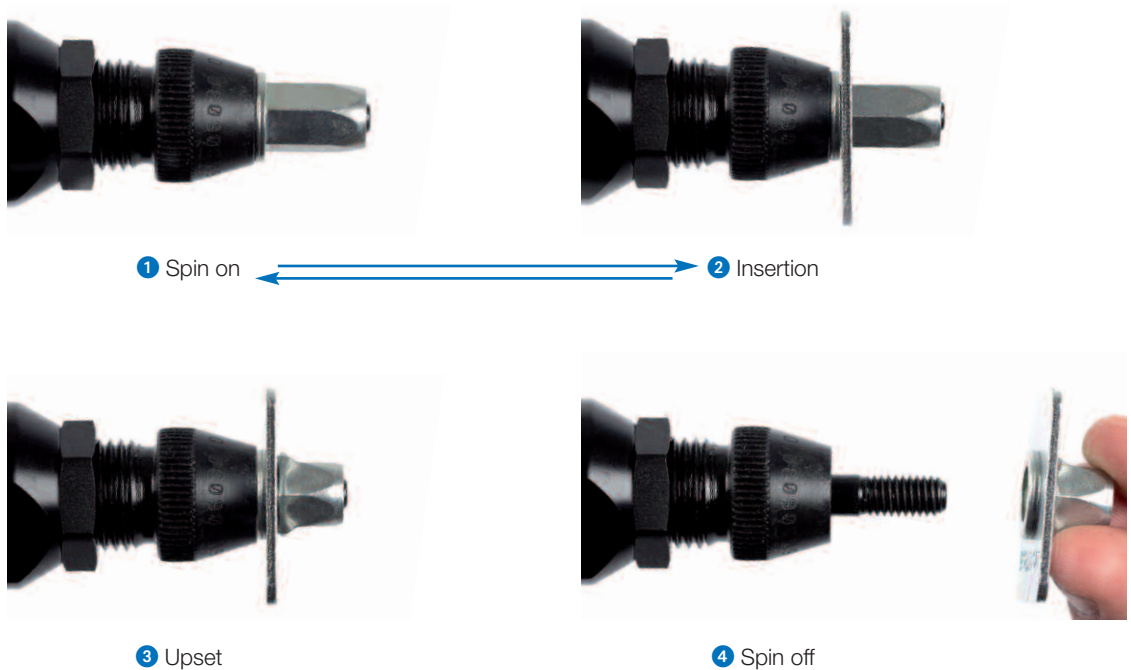

Our pressure setting method

Today, all the BÖLLHOFF setting tools use the pressure setting method. With this setting method, a tension force is applied in order to generate the deformation of the RIVKLE®.



Advantages

- Ensures a constant setting quality, particularly for applications with variable thicknesses.
- Allows the use of preventive controls.
- Quick and simple adjustment of the setting tools.
- Prevents damage to the setting tool or the RIVKLE® in the event of a 2nd setting cycle.
- Increased mandrel life.

Setting parameters

There are four required conditions for proper adjustment of a RIVKLE® fastener:

1. Make sure the RIVKLE® fastener touches the anvil: this means that "spin on" has been performed until the head of the RIVKLE® fastener touches the anvil.
2. Make sure the RIVKLE® fastener touches the workpiece: check that the rear face of the head of the RIVKLE® fastener lies flat against the surface of the workpiece.

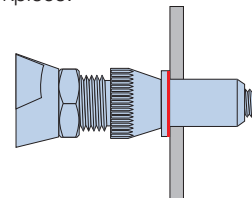
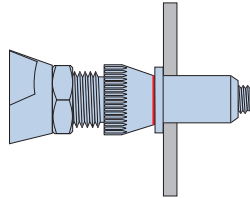

3. Apply the recommended setting force: adjustment and check should be done using the force controller specifically designed for our hand setting tools (integrated for automatic adjustment).
4. Make sure the tool is perpendicular to the surface of the workpiece: check that the top of the tool is aligned with the centreline of the thread during the spin on, setting and spin off steps.

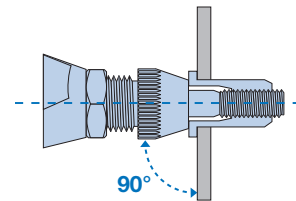
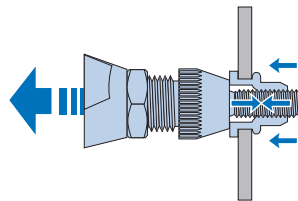

Recommended setting force

BÖLLHOFF has determined a recommended setting force for every RIVKLE® product.

This recommended setting force is defined to ensure:

- proper installation of the product throughout its entire setting range
- no "re-setting" of the product when the bolt is screwed in

To limit the need for tool adjustment, BÖLLHOFF develops its products in such a way that a recommended force is achieved for each diameter.

Installation force range per diameter & RIVKLE® material

	Steel Force in kN	Stainless steel Force in kN	Stainless steel A4 Force in kN	Aluminium Force in kN
M3	3,5	3,5	-	1,9
M4	5,5	5,5	9,5	3,0
M5	8,0	8,0	12,0	3,8
M6	12,0	13,0	15,0	5,5
M8	18,0	20,0	20,0	10,0
M10	21,0	22,0	-	12,0
M12	23,0	38,0	-	15,0
M14	50,0	-	-	-

For the ranges of RIVKLE® fasteners with additional functions, you will find the associated setting forces in the relevant product pages.

RIVKLE® – Material and surface treatment

Our standard surface treatment, Zn 8K+; 8 to 15 µm; provides the highest corrosion resistance in the standard market (400 hours to Red Rust according to ISO9227). For the most demanding applications, ZnNi8A/Fe; 8 to 15 µm, can be supplemented with either a lubricant and/or reinforcement to reach 720 or even 1000 hours to Red Rust.

	EN		USA
	Description	Num.	
Steel	C10C	1.0214	C1010
	C4C	1.0303	C1005
	11SMnPb30	1.0718	12L13
	20MnB5	1.5530	10B22
Stainless steel	X6CrNiCu18-9-2	1.4570 (A1)	AISI 303K
	X3CrNiCu18-9-4	1.4567 (A2)	AISI 302 HQ
	X3CrNiCuMo17-11-3-2	1.4578 (A4)	AISI 316 Cu
	X6Cr17*	1.4016*	AISI 430*
Aluminium	AW-AIMg2,5	AW-5052	5052
	EN AW-AI Mg1SiBi/EN	AW-60604	A/6064

*RIVKLE® PN



With the exception of the ranges below, which are suited for both industrial use and automotive use, all the other references are designed for industrial use only.

- RIVKLE® HRT (High Resistance Thread) nuts
- RIVKLE® SFC (Smart For Composite) nuts
- RIVKLE® Seal Ring nuts and studs
- Standard studs: refer to the last column related to coatings **1** = Zn8K+/Fe; **2** = ZnNi8A/Fe

Most of the articles in this catalogue are available in automotive variant. Please contact BÖLLHOFF.

RIVKLE® – Selection of the nut or stud

The references provided in the next pages of the catalogue and on our website will help you to select the RIVKLE® nut or stud suited to your application.

The RIVKLE® blind rivet nuts and studs are identified based on different product features:

BODY	<input type="checkbox"/>	>
HEAD	<input type="checkbox"/>	
BODY END	<input type="checkbox"/>	
MATERIAL	<input type="checkbox"/>	
DIAMETER	<input type="checkbox"/>	
GRIP THICKNESS	<input type="checkbox"/>	
PLATING	<input type="checkbox"/>	
ADDITIONAL FUNCTIONS	<input type="checkbox"/>	

BODY

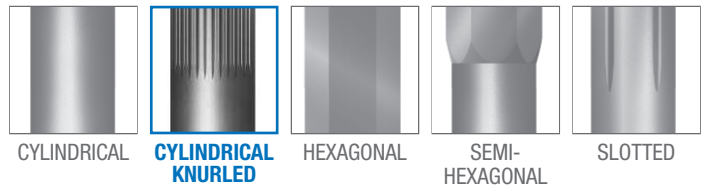

DIAMETER

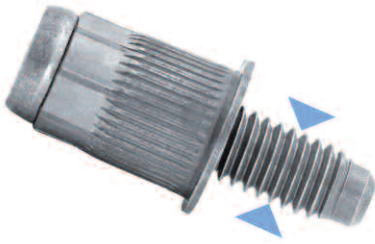

M3	M4	M5
M6	M8	M10
M12	M14	M16

- + BODY ✓
- + HEAD ✓
- + THREAD ✓
- + END ✓
- + MATERIAL ✓
- **DIAMETER** <
- + GRIP THICKNESS
- + PLATING
- + ADDITIONAL FUNCTIONS



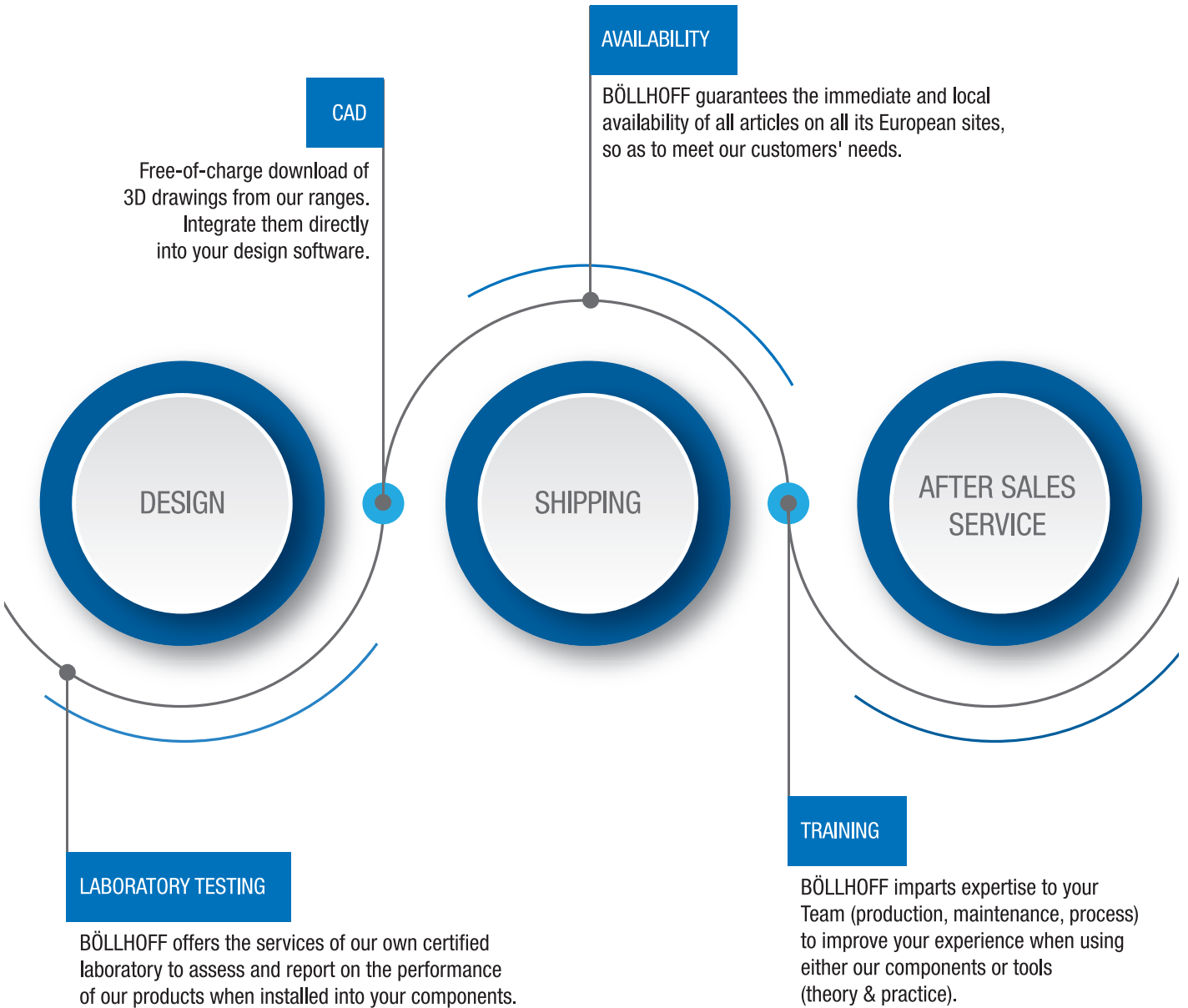

RIVKLE® – Legend

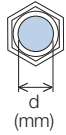
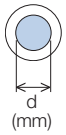

Thread size

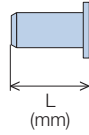

Overall length

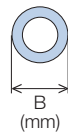

Head diameter

If round -> diameter
If hexagonal -> width across flats

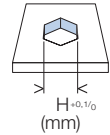
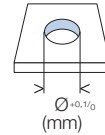

Hole geometry

If round -> diameter
If hexagonal -> width across flats

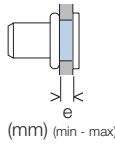

Grip range

Defines the range of total thickness of the customer part (even if it consists of more than one layer)

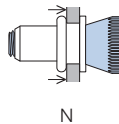

Setting load

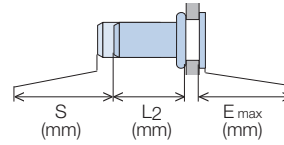

Head projection after setting

Variable according to the application (setting load, material substrate, etc.)

Blind side projection after installation

Defines the clearance needed on the blind side (cannot be used for quality control)

Setting stroke

Difference of total length before and after installation

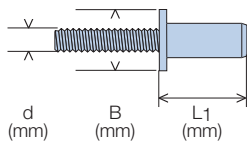

Tip diameter
Head diameter
Shank length

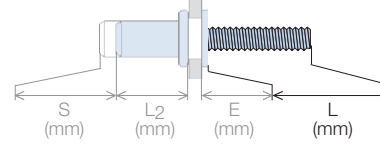

Tip length

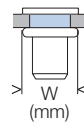

d (mm)	W (mm)
M3	6,8 mm
M4	8,6 mm
M5	10,1 mm
M6	13,0 mm
M8	15,0 mm
M10	18,0 mm
M12	22,4 mm

Maximum bulge diameter

RIVKLE® Nut

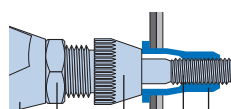

RIVKLE® Stud

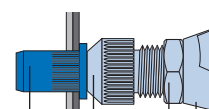

- RIVKLE®
- Mandrel*
- Customers part
- Anvil*
- Counter nut
- Setting tool

*in accordance to chosen RIVKLE®

RIVKLE®
THE STANDARD LINE



	Page
General presentation of the RIVKLE® product line	
An optimized assembly solution for improved performance	4
The RIVKLE® technology	6
Setting of RIVKLE® fasteners	7
Material and surface treatment	9
Selection of the nut or stud	10
Additional services	12
Legend	13
The standard RIVKLE® line	
Blind rivet nuts	16
Blind rivet studs	35
RIVKLE® product variants	
HRT nuts - High Resistance Thread	40
SFC nuts and studs - For fiber-reinforced polymer	42
PN nuts - Ultimate pull-out force	44
Seal Ring nuts and studs and other watertight solutions	46
The RIVKLE® setting tools	
Hand operated assembly tools	50
Hydropneumatic and battery-powered setting tools	53
Special installation machines	61
BÖLLHOFF is the only supplier for your assembly components and associated tools	
Part number index	64

RIVKLE® – Standard blind rivet nuts - Steel

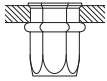

Steel | Thin head | Hexagonal | Open

	d (mm)	L (mm)	B (mm)	e (mm) (min - max)	H ^{+0.1/0} (mm)	S (mm)	L ₂ (mm)	E _{max} (mm)	
M3	10,25	5,0	1,5 - 2,5	5,0	S=3,8-e	6,0	0,3	343 41 030 025	
M4	10,8	6,5	0,5 - 3,0	6,0	S=4,5-e	6,2	0,4	343 41 040 030	
	13,5		3,0 - 5,5		S=7,2-e			343 41 040 055	
M5	13,8	7,85	0,5 - 3,0	7,0	S=4,5-e	9,0	0,45	343 41 050 030	
	16,5		3,0 - 5,5		S=7,2-e			343 41 050 055	
M6	16,2	9,95	0,5 - 3,5	9,0	S=5,5-e	10,2	0,45	343 41 060 030	
	19,25		3,5 - 6,0		S=8,5-e			343 41 060 060	
M8	17,8	11,75	0,5 - 3,5	11,0	S=5,5-e	12,5	0,4	343 41 080 030	
	20,8		3,5 - 6,0		S=8,5-e		0,5	343 41 080 060	
M10	22,0	14,1	1,0 - 3,5	13,0	S=6,0-e	16,0	0,5	343 41 100 035	
	25,0		3,0 - 6,0		S=8,6-e			343 41 100 060	
M12	24,8	17,6	1,0 - 4,0	16,0	S=7,8-e	14,0	0,85	343 41 120 040	
	27,7		4,0 - 8,0		S=13,5-e			343 41 120 080	

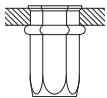

Steel | Thin head | Hexagonal | Closed

	d (mm)	L (mm)	B (mm)	e (mm) (min - max)	H ^{+0.1/0} (mm)	S (mm)	L ₂ (mm)	E _{max} (mm)	
M4	17,8	6,5	0,5 - 3,0	6,0	S=4,5-e	13,0	0,4	343 51 040 030	
M5	20,2	7,85	0,5 - 3,0	7,0	S=4,5-e	15,0	0,45	343 51 050 030	
M6	23,2	9,95	0,5 - 3,5	9,0	S=5,8-e	17,2	0,45	343 51 060 030	
	25,3		3,5 - 5,5		S=7,4-e			17,8	0,4
M8	28,3	11,75	0,5 - 3,5	11,0	S=5,8-e	22,5	0,5	343 51 080 030	
	30,5		3,5 - 6,0		S=8,5-e			22,0	343 51 080 060
M10	35,05	14,1	3,0 - 6,0	13,0	S=8,2-e	27,0	0,55	343 51 100 060	

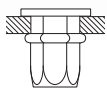

Steel | Flat head | Hexagonal | Open

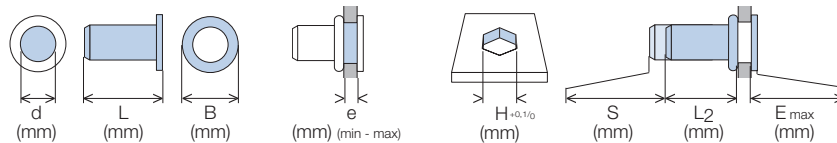

	d (mm)	L (mm)	B (mm)	e (mm) (min - max)	H ^{-0,1/0} (mm)	S (mm)	L ₂ (mm)	E _{max} (mm)	
M4	9,8	9,8	9,0	0,5 - 2,0	6,0	S=3,5-e	5,8	1,0	233 41 040 020
M5	13,7	14,3	10,0	0,5 - 3,0	7,0	S=5,0-e	8,0	1,0	233 41 050 030
				2,5 - 4,5		S=6,6-e	6,7		233 41 050 045
M6	15,7	18,7	12,9	0,5 - 3,0	9,0	S=4,5-e	10,0	1,5	233 41 060 030
				3,0 - 5,5		S=7,5-e			233 41 060 055
M8	17,75	20,75	16,0	0,5 - 3,0	11,0	S=5,5-e	11,0	1,5	233 41 080 030
				3,0 - 5,5		S=8,5-e			233 41 080 055
M10	22,8	25,45	19,0	1,0 - 3,5	13,0	S=6,0-e	15,0	2,0	233 41 100 035
				3,5 - 6,0		S=8,7-e			233 41 100 060
M12	26,8	26,8	23,0	1,0 - 4,0	16,0	S=7,7-e	17,0	2,0	233 41 120 030

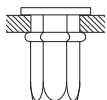

Steel | Flat head | Hexagonal | Closed

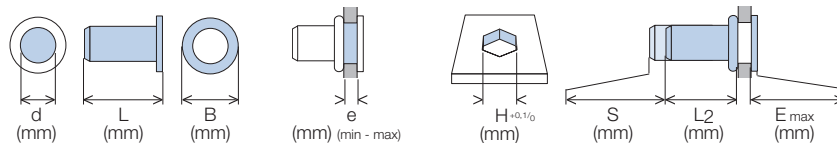

	d (mm)	L (mm)	B (mm)	e (mm) (min - max)	H ^{-0,1/0} (mm)	S (mm)	L ₂ (mm)	E _{max} (mm)	
M4	14,8	14,8	9,0	0,5 - 2,0	6,0	S=4,0-e	10,0	1,0	233 51 040 020
M5	19,7	19,7	10,0	0,5 - 3,0	7,0	S=5,0-e	14,0	1,0	233 51 050 030
M6	22,8	25,0	12,9	0,5 - 3,0	9,0	S=5,2-e	17,0	1,5	233 51 060 030
				3,0 - 5,5		S=7,5-e			233 51 060 055
M8	25,8	28,7	16,0	0,5 - 3,0	11,0	S=5,5-e	19,0	1,5	233 51 080 030
				3,0 - 5,5		S=8,3-e			233 51 080 055
M10	32,75	32,75	19,0	1,0 - 3,5	13,0	S=6,0-e	25,0	2,0	233 51 100 035

RIVKLE® – Standard blind rivet nuts - Steel

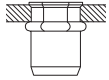

Steel | Thin head | Semi-Hexagonal | Open

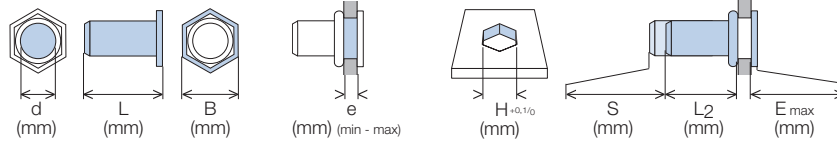

	d (mm)	L (mm)	B (mm)	e (mm) (min - max)	H ^{-0.1/0} (mm)	S (mm)	L ₂ (mm)	E max (mm)	
M4	10,7	10,7	6,7	0,5 - 3,0	6,0	S=4,5-e	6,0	0,3	343 41 040 230
M5	13,0	13,0	7,9	0,5 - 3,0	7,0	S=5,2-e	7,5	0,3	343 41 050 230
M6	13,75	13,75	9,8	0,5 - 3,0	9,0	S=5,3-e	8,3	0,4	343 41 060 230
M8	17,25	17,25	12,0	0,5 - 3,0	11,0	S=5,8-e	11,3	0,4	343 41 080 230

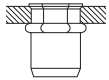

Steel | Thin head | Semi-Hexagonal | Open

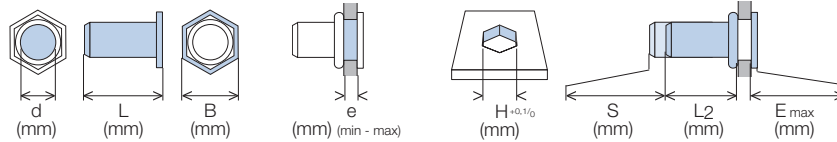

	d (mm)	L (mm)	B (mm)	e (mm) (min - max)	H ^{-0.1/0} (mm)	S (mm)	L ₂ (mm)	E max (mm)	
M4	10,3	10,3	6,9	0,5 - 2,0	6,4	S=3,0-e	6,8	0,5	343 21 040 020
M5	11,45	11,45	8,1	0,5 - 3,0	7,3	S=4,8-e	7,0	0,45	343 21 050 030
M6	14,35	14,35	10,6	0,7 - 3,0	9,7	S=4,8-e	9,0	0,6	343 21 060 030
M8	15,8	15,8	11,55	0,9 - 3,3	10,7	S=5,9-e	10,2	0,7	343 21 080 033

 For holes with imperial dimensions

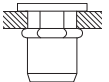

Steel | Flat head | Semi-Hexagonal | Open

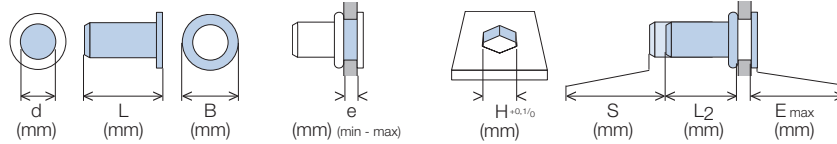

	d (mm)	L (mm)	B (mm)	e (mm) (min - max)	H ^{-0.1/0} (mm)	S (mm)	L ₂ (mm)	E max (mm)	
M4	11,0	11,0	9,0	0,5 - 3,0	6,0	S=4,3-e	5,8	1,0	233 41 040 230
M5	13,0	13,0	10,0	0,5 - 3,0	7,0	S=4,7-e	7,3	1,0	233 41 050 230
M6	14,25	14,25	13,0	0,5 - 3,0	9,0	S=5,0-e	8,0	1,5	233 41 060 230
M8	18,0	18,0	16,0	0,5 - 3,0	11,0	S=5,3-e	11,2	1,5	233 41 080 230

RIVKLE® - Other concepts



RIVKLE® Star Head

Flush finish with anti-turn - Ideal for wood

Steel | Thin head | Knurled | Open

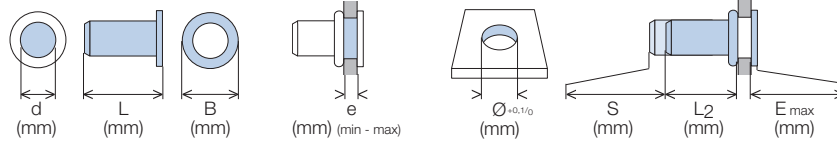
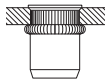

	d (mm)	L (mm)	B (mm)	e (mm) (min - max)	Ø ^{+0,1/0} (mm)	S (mm)	L ₂ (mm)	E _{max} (mm)	
M3	9,0	5,7		0,5 - 2,0		S=3,6-e	5,5		343 67 030 020
	9,8	5,75		1,5 - 3,0	5,0	S=3,6-e	5,7	0,4	343 67 030 030
M4	10,7			0,5 - 3,0		S=4,9-e	5,8	0,3	343 67 040 230
	11,9	6,6		2,5 - 4,0	6,0	S=5,6-e	5,9	0,4	343 67 040 040
M5	12,75	8,0		0,5 - 3,0		S=5,3-e	7,4	0,3	343 67 050 230
	13,8	7,6		2,5 - 4,0	7,0	S=5,8-e	7,6	0,4	343 67 050 040
M6	13,8	10,0		0,5 - 3,0		S=5,1-e		0,4	343 67 060 230
	15,3			3,0 - 4,5	9,0	S=6,6-e	8,5		343 67 060 045
	16,9	9,6		4,5 - 6,0		S=8,2-e		0,3	343 67 060 060
M8	17,25	12,0		0,5 - 3,0		S=6,0-e	11,1		343 67 080 230
	18,9			3,0 - 4,5	11,0	S=6,7-e		0,4	343 67 080 045
	20,5	11,8		4,5 - 6,0		S=8,3-e	11,8		343 67 080 060
M10	20,75	14,0		0,7 - 3,5		S=6,5-e		0,5	343 67 100 235
	21,9			3,0 - 4,5	13,0	S=7,5-e	14,0		343 67 100 045
	23,5	13,8		4,5 - 6,0		S=9,1-e		0,4	343 67 100 060
M12	25,8			3,0 - 4,5		S=7,5-e			343 67 120 045
	27,4	17,0		4,5 - 6,0	16,0	S=9,1-e	17,8	0,5	343 67 120 060

Steel | Thin head | Knurled | Closed

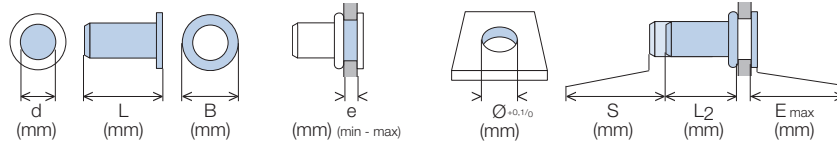
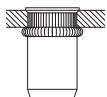

	d (mm)	L (mm)	B (mm)	e (mm) (min - max)	Ø ^{+0,1/0} (mm)	S (mm)	L ₂ (mm)	E _{max} (mm)	
M3	12,6			0,7 - 1,5		S=2,0-e			343 77 030 015
	14,2	5,8		1,5 - 3,0	5,0	S=3,6-e	10,2	0,3	343 77 030 030
M4	17,7	6,7		0,5 - 3,0		S=4,9-e	12,8		343 77 040 030
	16,9	6,6		2,5 - 4,0	6,0	S=5,7-e	10,9	0,3	343 77 040 040
M5	19,85	8,0		0,5 - 3,0		S=5,3-e	14,5		343 77 050 030
	19,8	7,6		2,5 - 4,0	7,0	S=6,0-e	13,5	0,3	343 77 050 040
M6	21,3	10,0		0,5 - 3,0		S=5,0-e	16,0	0,6	343 77 060 031
	20,3			3,0 - 4,5	9,0	S=6,6-e	13,5		343 77 060 045
	21,9	9,6		4,5 - 6,0		S=7,3-e	13,6	0,3	343 77 060 060
M8	23,3	11,8		0,8 - 3,0		S=4,8-e	18,0	0,4	343 77 080 030
	26,3	12,0		1,0 - 4,0	11,0	S=7,4-e	19,0	0,8	343 77 080 040
	24,9			3,0 - 4,5		S=6,7-e			343 77 080 045
	26,5	11,8		4,5 - 6,0		S=8,3-e	17,8	0,4	343 77 080 060
M10	28,3			0,8 - 3,0		S=5,5-e			343 77 100 030
	29,9	13,8		3,0 - 4,5	13,0	S=7,1-e	22,3	0,5	343 77 100 045
	31,5			4,5 - 6,0		S=8,7-e			343 77 100 060
M12	33,2	16,8		0,8 - 3,0		S=11,5-e	21,1		343 77 120 030
	34,8			3,0 - 4,5	16,0	S=7,9-e			343 77 120 045
	36,4	17,0		4,5 - 6,0		S=9,6-e	26,4	0,5	343 77 120 060

RIVKLE® – Standard blind rivet nuts - Steel

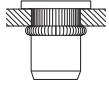

Steel | Flat head | Knurled | Open

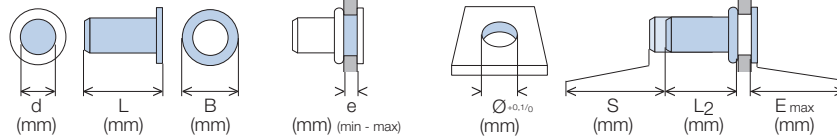

	d (mm)	L (mm)	B (mm)	e (mm) (min - max)	Ø ^{+0,1/0} (mm)	S (mm)	L ₂ (mm)	E _{max} (mm)	
M3	8,8			0,50 - 1,00		S=2,0-e	5,8		233 07 030 100
	9,6			1,00 - 1,75	5,0	S=2,8-e	6,0	1,0	233 07 030 175
	10,4		7,0	1,75 - 2,50		S=3,4-e			233 07 030 250
	11,2			2,50 - 3,25		S=4,1-e	6,1		233 07 030 325
M4	11,0		9,0	0,50 - 3,00	6,0	S=4,3-e	5,8	1,0	233 07 040 230
	11,6		8,0	2,50 - 3,25		S=4,6-e	6,0		233 07 040 325
M5	12,75		10,0	0,50 - 3,00	7,0	S=4,7-e	7,3	1,0	233 07 050 230
	14,7			3,00 - 4,00		S=6,0-e	8,0		233 07 050 040
M6	14,3		13,0	0,50 - 3,00	9,0	S=5,0-e	8,0	1,5	233 07 060 230
	16,9			3,00 - 5,50		S=7,5-e	8,2		233 07 060 255
M8	17,7		16,0	0,50 - 3,00	11,0	S=5,5-e	11,0	1,5	233 07 080 230
	20,4			3,00 - 5,50		S=8,1-e			233 07 080 255
M10	21,8		19,0	0,70 - 3,50		S=6,1-e	13,9		233 07 100 235
	24,0			3,00 - 4,50	13,0	S=7,4-e	14,6	2,0	233 07 100 450
	25,6		16,0	4,50 - 6,00		S=8,9-e	14,5		233 07 100 600

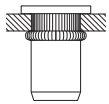

Steel | Flat head | Knurled | Closed

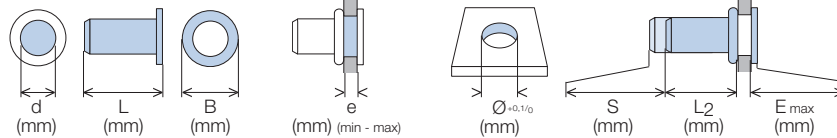

	d (mm)	L (mm)	B (mm)	e (mm) (min - max)	Ø ^{+0,1/0} (mm)	S (mm)	L ₂ (mm)	E _{max} (mm)	
M4	15,0			1,00 - 1,75		S=3,0-e	11,0		233 27 040 175
	15,8		8,0	1,75 - 2,50	6,0	S=3,5-e	11,3	1,0	233 27 040 250
	16,6			2,50 - 3,25		S=4,6-e	11,0		233 27 040 325
M5	17,6		9,0	0,50 - 1,00	7,0	S=2,0-e	14,6	1,0	233 27 050 100
	18,7			1,00 - 2,00		S=3,1-e			233 27 050 200
	19,8			2,00 - 3,00		S=4,2-e			233 27 050 300
M6	21,0		13,0	3,00 - 4,00	9,1	S=5,3-e	14,7	1,5	233 27 050 400
	21,5			0,50 - 3,00	9,0	S=4,5-e	15,0		233 27 060 030
	25,2		11,0	3,00 - 4,50		S=5,3-e	18,4		233 27 060 450
M8	26,5		14,0	2,00 - 3,50	11,0	S=5,5-e	19,5	1,5	233 27 080 350
	27,8			3,50 - 5,00		S=7,6-e	18,7		233 27 080 500
M10	32,3		16,0	1,50 - 3,00	13,0	S=6,0-e	25,0	2,0	233 27 100 300



Steel | Countersunk head | Knurled | Open

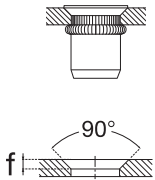
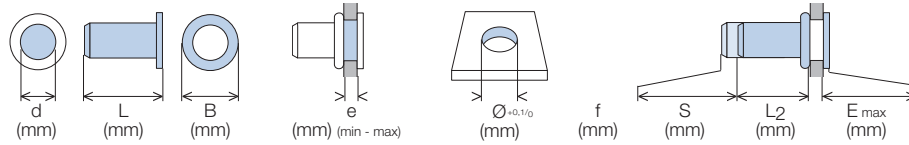

	d (mm)	L (mm)	B (mm)	e (mm) (min - max)	Ø ^{+0,1/0} (mm)	f (mm)	S (mm)	L ₂ (mm)	E _{max} (mm)	
M3	8,8	6,6		1,00 - 1,75		1,0	S=2,8-e	5,9		233 17 030 175
	9,6	7,0		1,75 - 2,50	5,0	1,2	S=3,5-e	6,0	0,1	233 17 030 250
	10,4			2,50 - 3,25			S=4,3-e			233 17 030 325
M4	9,2			1,00 - 1,75		1,0	S=2,8-e			233 17 040 175
	10,0	8,0		1,75 - 2,50	6,0	1,2	S=3,6-e	6,3	0,1	233 17 040 250
	10,8			2,50 - 3,25			S=4,3-e	6,4		233 17 040 325
M5	11,6	8,5		1,00 - 2,00		1,0	S=3,8-e			233 17 050 200
	12,7			1,50 - 3,00	7,0	1,4	S=3,8-e		0,1	233 17 050 300
	13,8	9,0		3,00 - 4,00			S=5,2-e	8,5		233 17 050 400
M6	14,9			4,00 - 5,00			S=6,3-e			233 17 050 500
	15,0			1,50 - 3,00		1,2	S=5,0-e			233 17 060 300
	16,6	10,6		3,00 - 4,50	9,0	1,5	S=6,5-e	10,0	0,1	233 17 060 450
M8	18,2			4,50 - 6,00			S=8,0-e			233 17 060 600
	19,8	11,0		6,00 - 7,50			S=9,4-e	10,3		233 17 060 750
	16,5	12,6		1,50 - 3,00		1,4	S=6,0-e			233 17 080 300
M10	18,1	13,6		3,00 - 4,50	11,0	2,0	S=7,5-e	11,5	0,1	233 17 080 450
	19,7	14,0		4,50 - 6,00			S=8,6-e	11,0		233 17 080 600
	20,4	15,0		1,50 - 3,00		1,4	S=5,7-e			233 17 100 300
M10	22,0			3,00 - 4,50	13,0	2,0	S=7,3-e		0,1	233 17 100 450
	23,6	16,0		4,50 - 6,00			S=8,9-e	14,6		233 17 100 600



Steel | Countersunk head | Knurled | Closed

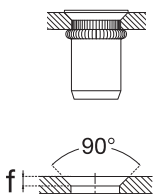
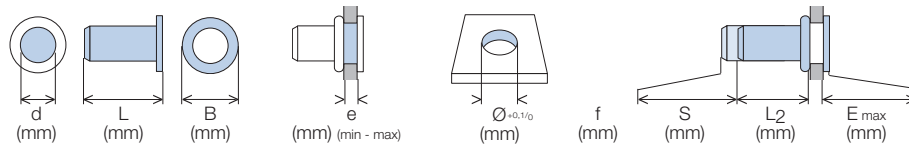

	d (mm)	L (mm)	B (mm)	e (mm) (min - max)	Ø ^{+0,1/0} (mm)	f (mm)	S (mm)	L ₂ (mm)	E _{max} (mm)	
M4	14,2			1,00 - 1,75		1,0	S=2,8-e			233 37 040 175
	15,0	8,0		1,75 - 2,50	6,0	1,2	S=3,6-e	11,3	0,1	233 37 040 250
	15,8			2,50 - 3,25			S=4,7-e	11,5		233 37 040 325
M5	17,7	8,5		1,00 - 2,00		1,0	S=3,0-e			233 37 050 200
	18,8	9,0		2,00 - 3,00	7,0	1,4	S=4,1-e	14,6	0,1	233 37 050 300
	21,0			3,00 - 5,00		1,4	S=6,3-e			233 37 050 500
M6	22,0			1,50 - 3,00			S=4,6-e			233 37 060 300
	23,6	11,0		3,00 - 4,50	9,0	1,5	S=6,2-e	17,3	0,1	233 37 060 450
	25,2			4,50 - 6,00			S=7,8-e			233 37 060 600
M8	26,8			6,00 - 7,50			S=9,4-e			233 37 060 750
	24,8	12,6		1,50 - 3,00		1,4	S=6,0-e	19,8		233 37 080 300
	26,4			3,00 - 4,50			S=7,0-e			233 37 080 450
M10	28,0	14,0		4,50 - 6,00	11,0	2,0	S=8,6-e	19,3	0,1	233 37 080 600
	29,6			6,00 - 7,50			S=10,2-e			233 37 080 750
	30,3	15,0		1,50 - 3,00		1,4	S=4,3-e			233 37 100 300
M10	31,9			3,00 - 4,50	13,0	2,0	S=5,3-e		0,1	233 37 100 450
	33,5	16,0		4,50 - 6,00			S=8,9-e	24,5		233 37 100 600

RIVKLE® – Standard blind rivet nuts - Steel

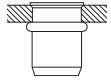

Steel | Thin head | Plain | Open

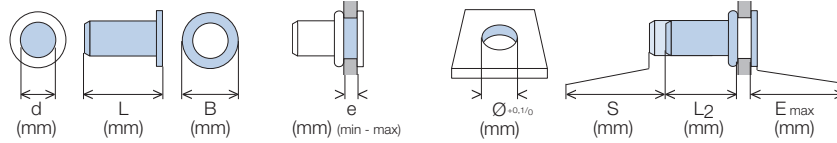

	d (mm)	L (mm)	B (mm)	e (mm) (min - max)	Ø ^{+0,1/0} (mm)	S (mm)	L ₂ (mm)	E ^{max} (mm)	
M3	8,4	8,4	5,2	0,5 - 1,5	4,7	S=2,8-e	5,5	0,4	343 01 030 150
M4	10,2	10,2	6,9	0,5 - 2,0	6,4	S=3,5-e	7,3	0,5	343 01 040 150
M5	11,25	11,25	7,6	0,5 - 3,0	7,1	S=4,5-e	7,3	0,6	343 01 050 150
M6	14,95	14,95	10,35	0,7 - 3,0	9,5	S=5,5-e	9,3	0,6	343 01 060 200
M8	16,6	16,6	11,5	0,8 - 4,5	10,5	S=7,5-e	9,6	0,7	343 01 080 450



For holes with imperial dimensions

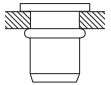

Steel | Flat head | Plain | Open

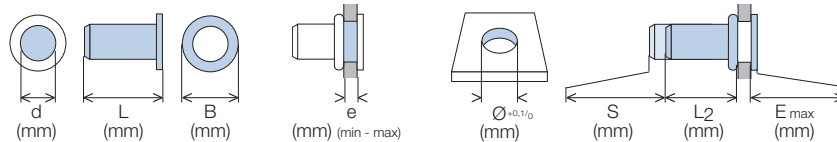

	d (mm)	L (mm)	B (mm)	e (mm) (min - max)	Ø ^{+0,1/0} (mm)	S (mm)	L ₂ (mm)	E ^{max} (mm)	
M3	8,3	7,5	7,5	0,5 - 1,0	5,0	S=2,1-e	5,2	1,0	233 01 030 010
	8,7			1,0 - 1,5		S=3,2-e	4,8		233 01 030 015
	9,7			1,5 - 3,0		S=4,2-e	4,4		233 01 030 030
	11,2			3,0 - 4,5		S=5,8-e	4,4		233 01 030 045
	12,9			4,5 - 6,0		S=7,2-e	4,7		233 01 030 060
M4	9,7	9,0	9,0	0,5 - 1,0	6,0	S=2,6-e	5,4	1,0	233 01 040 010
	10,2			1,0 - 2,0		S=3,6-e	5,6		233 01 040 020
	11,8			2,0 - 4,0		S=5,6-e	5,6		233 01 040 040
	13,8			4,0 - 6,0		S=7,5-e	5,3		233 01 040 060
M5	13,75	10,0	10,0	0,5 - 3,0	7,0	S=5,0-e	8,0	1,0	233 01 050 030
	16,7			3,0 - 5,5		S=7,5-e	9,1		233 01 050 055
	19,8			5,5 - 8,0		S=9,7-e	9,1		233 01 050 080
M6	15,8	13,0	13,0	0,5 - 3,0	9,0	S=5,2-e	10,0	1,5	233 01 060 030
	18,7			3,0 - 5,5		S=7,9-e	9,3		233 01 060 055
	21,7			5,5 - 8,0		S=10,2-e	10,0		233 01 060 080
M8	17,8	16,0	16,0	0,5 - 3,0	11,0	S=5,7-e	11,0	1,5	233 01 080 030
	20,8			3,0 - 5,5		S=8,2-e	11,7		233 01 080 055
	23,8			5,5 - 8,0		S=10,6-e	11,8		233 01 080 080
	26,8			8,0 - 10,5		S=13,5-e	11,8		233 01 080 105
M10	22,75	19,0	19,0	1,0 - 3,5	13,0	S=6,5-e	15,0	2,0	233 01 100 035
	25,75			3,5 - 6,0		S=9,0-e	15,0		233 01 100 060
	27,75			6,0 - 8,5		S=11,5-e	17,5		233 01 100 085
	31,8			8,5 - 11,0		S=14,0-e	17,5		233 01 100 110
M12	26,7	23,0	23,0	1,0 - 4,0	16,0	S=7,7-e	17,1	2,0	233 01 120 040
	29,7			4,0 - 7,0		S=10,7-e	17,5		233 01 120 070
	34,8			7,0 - 10,0		S=13,7-e	17,5		233 01 120 100
M14	35,5	24,0	24,0	4,5 - 6,0	18,0	S=9,8-e	23,2	2,5	233 01 140 600

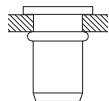

Steel | Flat head | Plain | Closed

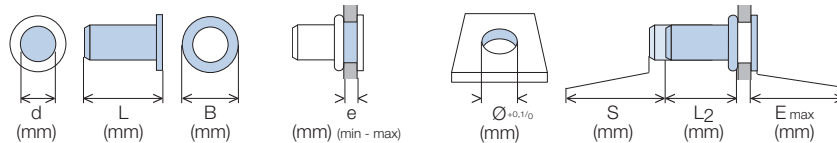

	d (mm)	L (mm)	B (mm)	e (mm) (min - max)	Ø ^{+0,1/0} (mm)	S (mm)	L ₂ (mm)	E ^{max} (mm)	
M3	14,3	7,5		1,5 - 3,0	5,0	S=4,1-e	9,2	1,0	233 21 030 030
M4	15,25	9,0		1,0 - 2,0	6,0	S=5,2-e	10,4	1,0	233 21 040 020
	16,75			2,0 - 4,0		S=5,6-e			233 21 040 040
M5	18,8	10,0		4,0 - 6,0	7,0	S=7,6-e	10,3	1,0	233 21 040 060
	19,7			0,5 - 3,0		S=5,0-e			233 21 050 030
	22,7			3,0 - 5,5		S=7,5-e			233 21 050 055
M6	25,7	13,0		5,5 - 8,0	9,0	S=9,6-e	15,1	1,5	233 21 050 080
	22,7			0,5 - 3,0		S=4,9-e			233 21 060 030
	28,7			3,0 - 5,5		S=7,7-e			233 21 060 055
M8	25,7	16,0		5,5 - 8,0	11,0	S=10,2-e	17,0	1,5	233 21 060 080
	28,7			0,5 - 3,0		S=5,7-e			233 21 080 030
	31,7			3,0 - 5,5		S=8,2-e			233 21 080 055
	34,8			5,5 - 8,0		S=10,7-e			233 21 080 080
M10	32,7	19,0		8,0 - 10,5	13,0	S=12,9-e	20,4	2,0	233 21 080 105
	35,8			1,0 - 3,5		S=6,5-e			233 21 100 035
	38,8			3,5 - 6,0		S=8,4-e			233 21 100 060
M12	38,8	23,0		6,0 - 8,5	16,0	S=11,2-e	25,6	2,0	233 21 100 085
	41,8			1,0 - 4,0		S=7,2-e			233 21 120 040
				4,0 - 7,0		S=10,4-e	29,4		233 21 120 070

RIVKLE® – Standard blind rivet nuts - Steel

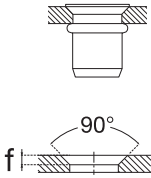

Steel | Countersunk head | Plain | Open

	(mm)	(mm)	(mm)	(mm) (min - max)	(mm)	(mm)	(mm)	(mm)	(mm)		
M3	8,3			1,0 - 1,5	5,0	0,9	S=2,8-e	5,4	1,0	233 11 030 015	
	8,8	6,6		1,5 - 3,0		1,3	S=4,3-e	4,8	1,4	233 11 030 030	
	10,3			3,0 - 4,5			S=4,9-e	4,7		233 11 030 045	
M4	9,8	7,2		1,0 - 2,0	6,0	0,9	S=3,7-e	5,4	0,1	233 11 040 020	
	10,4			2,0 - 3,0			S=4,7-e				233 11 040 030
	11,8	7,8		3,0 - 5,0		1,3	S=6,6-e			233 11 040 050	
	13,8	8,0		5,0 - 7,0			S=8,4-e	5,3		233 11 040 070	
M5	13,7	9,2		1,5 - 4,0	7,0	1,5	S=6,5-e	8,0	0,1	233 11 050 040	
	16,7			4,0 - 6,5			S=8,1-e	8,6		233 11 050 065	
	19,8	9,6		6,5 - 9,0			S=10,7-e	9,0		233 11 050 090	
M6	17,3			1,5 - 4,0	9,0	1,5	S=6,2-e	10,0	0,1	233 11 060 040	
	20,3	11,3		4,0 - 6,5			S=8,7-e				233 11 060 065
	21,8			6,5 - 9,0			S=10,4-e			11,4	233 11 060 090
M8	17,8			1,5 - 4,0	11,0	1,5	S=7,0-e	11,0	0,1	233 11 080 040	
	20,8	13,1		4,0 - 6,5			S=9,5-e				233 11 080 065
	23,75			6,5 - 9,0			S=12,0-e				233 11 080 090
M10	21,8			1,5 - 4,0	13,0	1,5	S=8,4-e	15,0	0,1	233 11 100 040	
	24,75	15,1		4,0 - 6,5			S=8,4-e				233 11 100 065
	28,0			6,5 - 9,0			S=11,5-e			14,8	233 11 100 090
M12	25,9			1,7 - 4,5	16,0	1,7	S=8,2-e	17,5	0,1	233 11 120 045	
	29,0	19,0		4,5 - 7,5			S=9,7-e				233 11 120 075
	31,8			7,5 - 10,5			S=13,7-e			18,0	233 11 120 105

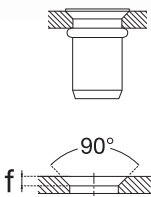

Steel | Countersunk head | Plain | Closed

	(mm)	(mm)	(mm)	(mm) (min - max)	(mm)	(mm)	(mm)	(mm)	(mm)		
M3	13,5	6,6		1,0 - 1,5	5,0	0,9	S=2,8-e	10,0	0,1	233 31 030 015	
	14,2			1,5 - 3,0		1,3	S=4,3-e	8,8		233 31 030 030	
M4	15,8	7,5		1,0 - 2,0	6,0	0,9	S=2,8-e	11,9	0,1	233 31 040 020	
	16,7			2,0 - 3,0			S=4,7-e	10,1		233 31 040 030	
	18,2	7,8		3,0 - 5,0		1,3	S=6,3-e	10,4		233 31 040 050	
	20,2			5,0 - 7,0			S=8,4-e	10,3		233 31 040 070	
M5	21,3	9,2		1,5 - 4,0	7,0	1,5	S=6,5-e	14,0	0,1	233 31 050 040	
	24,4			4,0 - 6,5			S=8,1-e	14,6		233 31 050 065	
	25,9	9,6		6,5 - 9,0			S=10,7-e	15,1		233 31 050 090	
M6	22,7			1,5 - 4,0	9,0	1,5	S=6,2-e	17,0	0,1	233 31 060 040	
	27,3	11,3		4,0 - 6,5			S=8,7-e				233 31 060 065
	28,8			6,5 - 9,0			S=10,5-e			19,4	233 31 060 090
M8	25,7			1,5 - 4,0	11,0	1,5	S=7,0-e	19,0	0,1	233 31 080 040	
	28,8	13,1		4,0 - 6,5			S=7,0-e				233 31 080 065
	31,8			6,5 - 9,0			S=11,3-e			20,4	233 31 080 090
M10	31,8			1,5 - 4,0	13,0	1,5	S=6,3-e	25,4	0,1	233 31 100 040	
	34,0	15,5		4,0 - 6,5			S=8,9-e			233 31 100 065	
	38,0			6,5 - 9,0			S=12,3-e	25,8		233 31 100 090	
M12	37,8			1,7 - 4,5	16,0	1,7	S=7,2-e	30,5	0,1	233 31 120 045	
	40,8	19,0		4,5 - 7,5			S=10,4-e			233 31 120 075	
	43,8			7,5 - 10,5			S=13,4-e	30,3		233 31 120 105	

RIVKLE® – Standard blind rivet nuts - Stainless steel

Industrial markets are constantly changing, bringing new applications and new customer needs. In order to support our customers and answer at best to their needs, BÖLLHOFF has renewed and developed a dedicated stainless steel range.

RIVKLE® Stainless steel - Lubricated range

The lubricated range is based on standard products on which a lubricant has been applied to limit galling issues. Customers don't need anymore to add manually any lubricant product (paste, spray, oil...).

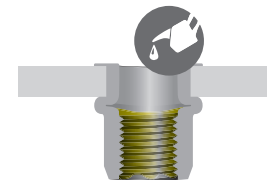

Stainless steel | Thin head | Semi-hexagonal | Open

	d (mm)	L (mm)	B (mm)	e (mm) (min - max)	H ^{+0,1/0} (mm)	S (mm)	L ₂ (mm)	E _{max} (mm)				
M3	8,6	9,5	5,8	1,0 - 2,3	5,0	S=3,8-e	4,5	0,4	343 98 030 590			
				2,3 - 3,2		S=4,7-e			343 98 030 591			
M4	10,4	11,7	6,7	0,5 - 2,0	6,0	S=3,1-e	6,8	0,4	343 48 040 020*	343 49 040 506*		
				0,8 - 3,0		S=4,2-e			343 48 040 030*	343 49 040 507*		
				3,0 - 4,2		S=5,8-e			343 98 040 629*			
M5	12,0	12,8	7,8	0,5 - 3,0	7,0	S=4,4-e	7,0	0,45	343 48 050 020*	343 49 050 538*		
				8,9		3,0 - 4,5		S=6,5-e	6,5	0,4	343 98 050 629	
M6	14,5	14,3	10,2	0,5 - 3,0	9,0	S=4,2-e	9,7	0,45	343 48 060 025			
				9,7		0,5 - 3,0		S=7,4-e	8,7	0,45	343 98 060 624*	343 98 060 637*
				10,2		3,0 - 5,5		S=8,0-e	8,5	0,45	343 98 060 055*	
				11,1		4,0 - 5,5		S=7,0-e	10,4	0,5	343 48 060 630	
M8	15,8	17,6	12,5	0,5 - 3,0	11,0	S=4,7-e	10,4	0,3	343 48 080 030*	343 98 080 631*		
				1,5 - 5,0		S=7,0-e			10,2	0,3	343 98 080 625*	
M10	19,4	21,5	14,2	1,0 - 3,5	13,0	S=7,0-e	12,0	0,7	343 48 100 035	343 49 100 501		
				2,5 - 5,5		S=9,1-e			12,5	0,65	343 98 100 691	
M12	23,5	23,5	17,4	1,0 - 4,5	16,0	S=8,5-e	15,0	0,7	343 98 120 501			

*Extra-flat thin head

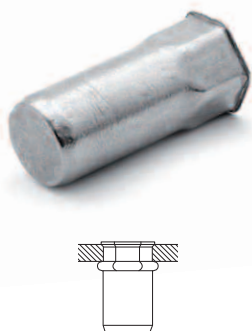

Stainless steel | Thin head | Semi-hexagonal | Closed

	d (mm)	L (mm)	B (mm)	e (mm) (min - max)	H ^{+0,1/0} (mm)	S (mm)	L ₂ (mm)	E _{max} (mm)		
M3	13,3	14,2	5,8	1,0 - 2,3	5,0	S=3,8-e	9,0	0,4	343 98 030 592	
				2,3 - 3,2		S=4,7-e			343 98 030 593	
M4	15,4	17,3	6,7	0,5 - 2,5	6,0	S=3,8-e	11,5	0,4	343 58 040 025*	343 59 040 505*
				7,8		3,0 - 4,2			S=5,8-e	343 98 040 630
M5	17,4	20,3	7,8	0,5 - 3,0	7,0	S=4,4-e	12,5	0,45	343 58 050 020*	343 59 050 505*
				3,0 - 4,5		S=6,5-e		13,4	0,5	343 98 050 683
M6	20,5	23,0	9,8	0,5 - 3,0	9,0	S=4,1-e	15,0	0,6	343 58 060 030	
				10,2		3,0 - 5,5		S=7,4-e	15,2	0,45
M8	26,6	26,6	12,5	1,5 - 5,0	11,0	S=7,0-e	19,0	0,3	343 98 080 629	
M10	29,3	31,3	15,6	1,0 - 3,5	13,0	S=7,0-e	22,0	0,65	343 98 100 692	
				2,5 - 5,5		S=9,0-e			343 98 100 693	
M12	34,0	34,0	18,9	1,0 - 4,5	16,0	S=8,5-e	26,4	0,7	343 98 120 502	

*Extra-flat thin head

RIVKLE® – Standard blind rivet nuts - Stainless steel

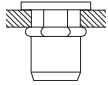

Stainless steel | Flat head | Semi-hexagonal | Open

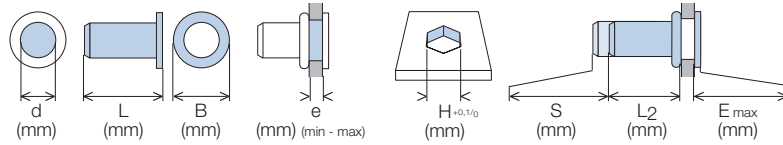

	d (mm)	L (mm)	B (mm)	e (mm) (min - max)	H (+0,1/0) (mm)	S (mm)	L2 (mm)	E max (mm)	
M3	9,0	7,0		1,0 - 2,3	5,0	S=3,1-e	5,0	0,7	233 48 030 023
	9,7			2,3 - 3,0		S=4,5-e			233 48 030 030
M4	12,0	9,0		0,5 - 2,0	6,0	S=3,5-e	5,4	1,0	233 48 040 020
	12,1			2,0 - 3,5		S=5,5-e			6,0
M5	12,5	10,0		0,5 - 3,0	7,0	S=4,7-e	8,0	1,0	233 48 050 030
	14,0			2,0 - 4,0		S=4,8-e			7,5
M6	15,8	12,0		0,5 - 3,0	9,0	S=4,0-e	9,7	1,5	233 48 060 001
	16,0			3,0 - 4,5		S=7,1-e			9,0
M8	16,5	14,0		0,5 - 3,0	11,0	S=5,4-e	9,6	1,5	233 48 080 001
	18,5			3,0 - 5,5		S=7,4-e			233 48 080 002
M10	21,0	17,0		1,0 - 3,5	13,1	S=6,5-e	13,7	2,0	233 48 100 035
	22,7			3,5 - 5,5		13,0			S=9,4-e
M12	24,2	20,0		1,0 - 4,5	16,0	S=8,5-e	15,0	1,8	233 48 120 045

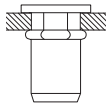

Stainless steel | Flat head | Semi-hexagonal | Closed

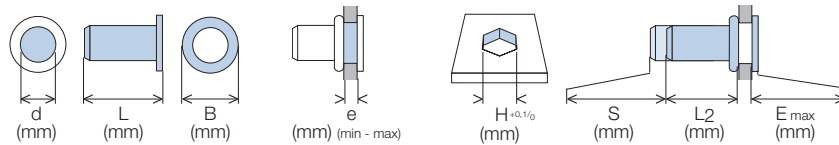

	d (mm)	L (mm)	B (mm)	e (mm) (min - max)	H (+0,1/0) (mm)	S (mm)	L2 (mm)	E max (mm)	
M3	12,7	7,0		1,1 - 2,3	5,0	S=3,8-e	9,2	0,7	233 58 030 023
	14,3			2,3 - 3,0		S=4,5-e			9,5
M4	15,5	8,0		0,5 - 2,0	6,0	S=3,8-e	11,5	0,8	233 58 040 020
	17,5			2,0 - 3,5		S=5,6-e			233 58 040 040
M5	19,6	9,0		0,5 - 3,0	7,0	S=5,0-e	12,5	1,0	233 58 050 001
	20,0			2,0 - 4,0		S=6,1-e			13,5
M6	22,3	12,0		0,5 - 3,0	9,1	S=4,0-e	15,5	1,5	233 58 060 030
	23,7			3,0 - 4,5		9,0			S=7,1-e
M8	26,1	14,0		0,8 - 3,0	11,0	S=5,3-e	19,5	1,5	233 58 080 001
	27,0			3,0 - 5,5		S=8,2-e			18,0
M10	31,5	16,0		1,0 - 3,5	13,0	S=7,4-e	27,5	1,8	233 58 100 035
	33,5			3,5 - 5,5		S=9,4-e			233 58 100 055
M12	35,0	20,0		1,0 - 4,5	16,0	S=8,5-e	29,5	1,8	233 58 120 045

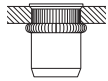

Stainless steel | Thin head | Knurled | Open

	d (mm)	L (mm)	B (mm)	e (mm) (min - max)	$\varnothing^{+0.1/0}$ (mm)	S (mm)	L ₂ (mm)	E _{max} (mm)	
M3	8,7	6,0	6,0	0,7 - 1,5	5,0	S=2,4-e	5,9	0,3	343 66 030 015
	7,9			1,5 - 2,5		S=3,5-e			343 66 030 025
	10,5			2,0 - 3,2		S=4,6-e			343 66 030 032
M4	11,6	7,0	7,0	0,7 - 3,0	6,0	S=4,0-e	7,5	0,5	343 66 040 230
	12,5			2,5 - 4,2		S=4,6-e			343 66 040 042
M5	12,3	8,0	8,0	0,7 - 3,3	7,0	S=4,4-e	8,0	0,5	343 66 050 233
	14,5			3,3 - 4,5		S=6,3-e			343 66 050 045
M6	14,5	10,0	10,0	0,7 - 3,3	9,0	S=5,7-e	8,6	0,6	343 66 060 233
	17,5			3,0 - 5,5		S=7,5-e			343 66 060 055
	17,0			4,5 - 6,0		S=7,9-e			343 66 060 060
M8	16,1	12,0	12,0	0,7 - 3,3	11,0	S=6,5-e	9,5	0,6	343 66 080 233
	18,6			3,3 - 5,5		S=9,0-e			343 66 080 255
	19,1			4,5 - 6,0		S=7,9-e			343 66 080 060
M10	18,3	14,0	14,0	0,8 - 1,5	13,0	S=3,9-e	13,9	0,4	343 66 100 015
	19,9			1,5 - 3,0		S=5,5-e			343 66 100 030
	21,5			3,0 - 4,5		S=7,1-e			343 66 100 045
	23,1			4,5 - 6,0		S=8,7-e			343 66 100 060
M12	21,5	17,0	17,0	0,8 - 1,5	16,0	S=3,8-e	17,2	0,4	343 66 120 015
	23,1			1,5 - 3,0		S=5,4-e			343 66 120 030
	24,7			3,0 - 4,5		S=7,0-e			343 66 120 045
	26,3			4,5 - 6,0		S=8,6-e			343 66 120 060

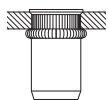

Stainless steel | Thin head | Knurled | Closed

	d (mm)	L (mm)	B (mm)	e (mm) (min - max)	$\varnothing^{+0.1/0}$ (mm)	S (mm)	L ₂ (mm)	E _{max} (mm)	
M3	13,0	6,0	6,0	0,7 - 1,5	5,0	S=2,4-e	10,2	0,3	343 76 030 015
	14,1			1,5 - 2,5		S=3,5-e			343 76 030 025
	14,8			2,0 - 3,2		S=4,6-e			343 76 030 032
M4	15,7	7,0	7,0	0,7 - 3,0	6,0	S=3,8-e	12,0	0,5	343 76 040 030
	16,7			2,5 - 3,5		S=4,0-e			343 76 040 035
M5	17,5	8,0	8,0	2,5 - 4,2	7,0	S=4,7-e	11,9	0,3	343 76 040 042
	17,8			0,8 - 2,0		S=3,2-e			343 76 050 020
	18,9			2,0 - 3,0		S=4,3-e			343 76 050 030
M6	20,5	10,0	10,0	3,0 - 4,5	9,0	S=5,4-e	13,6	0,4	343 76 050 045
	17,3			0,8 - 1,5		S=3,1-e			343 76 060 015
	18,8			1,5 - 3,0		S=4,7-e			343 76 060 030
	20,4			3,0 - 4,5		S=6,3-e			343 76 060 045
M8	22,0	12,0	12,0	4,5 - 6,0	11,0	S=7,9-e	16,7	0,4	343 76 060 060
	20,3			0,8 - 1,5		S=3,1-e			343 76 080 015
	21,9			1,5 - 3,0		S=4,7-e			343 76 080 030
	23,5			3,0 - 4,5		S=6,3-e			343 76 080 045
M10	25,1	14,0	14,0	4,5 - 6,0	13,0	S=7,9-e	21,9	0,4	343 76 080 060
	26,3			0,8 - 1,5		S=3,9-e			343 76 100 015
	27,9			1,5 - 3,0		S=5,5-e			343 76 100 030
	29,5			3,0 - 4,5		S=7,1-e			343 76 100 045
M12	31,1	17,0	17,0	4,5 - 6,0	16,0	S=8,7-e	26,2	0,4	343 76 100 060
	30,5			0,8 - 1,5		S=3,8-e			343 76 120 015
	32,1			1,5 - 3,0		S=5,4-e			343 76 120 030
	33,7			3,0 - 4,5		S=7,0-e			343 76 120 045
	35,3	4,5 - 6,0	S=8,6-e	343 76 120 060					

RIVKLE® – Standard blind rivet nuts - Stainless steel

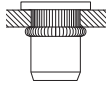

Stainless steel | Flat head | Knurled | Open

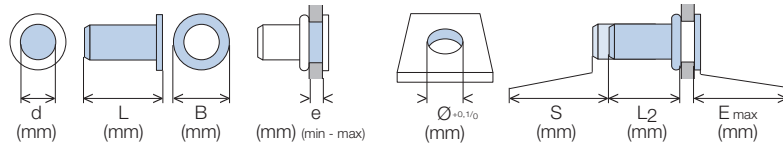

	d (mm)	L (mm)	B (mm)	e (mm) (min - max)	Ø ^{+0,10} (mm)	S (mm)	L ₂ (mm)	E max (mm)	
M3	9,3			0,7 - 1,5		S=2,4-e			233 06 030 015
	10,4	7,0		1,5 - 2,5	5,0	S=3,5-e	5,9	1,0	233 06 030 025
	11,0			2,0 - 3,2		S=4,4-e			233 06 030 032
M4	11,9	8,0		0,7 - 3,0	6,0	S=4,0-e	6,5	1,0	233 06 040 230
	12,4			2,5 - 4,2		S=4,7-e	6,0		233 06 040 042
M5	12,7	9,0		0,7 - 3,3	7,0	S=5,3-e	7,2	1,0	233 06 050 233 233 09 050 501
	14,9			3,0 - 4,5		S=5,4-e	7,8		233 06 050 045
M6	15,2	12,0		0,7 - 3,3		S=5,7-e		1,5	233 06 060 233 233 09 060 501
	16,4	11,0		3,0 - 4,5	9,0	S=6,3-e	8,6	1,5	233 06 060 045
	18,2			4,5 - 6,0		S=7,9-e			233 06 060 060
M8	16,9			0,7 - 3,3		S=6,5-e		1,5	233 06 080 233 233 09 080 501
	19,0	14,0		3,0 - 5,5	11,0	S=8,5-e	9,5	1,5	233 06 080 255
	20,0			4,5 - 6,0		S=7,9-e	10,6		233 06 080 060
M10	19,8			0,8 - 1,5		S=3,9-e		2,0	233 06 100 015
	21,4	16,0		1,5 - 3,0	13,0	S=5,5-e	13,9	2,0	233 06 100 030
	23,0			3,0 - 4,5		S=7,1-e			233 06 100 045
	24,6			4,5 - 6,0		S=8,7-e			233 06 100 060
M12	23,0			0,8 - 1,5		S=3,8-e		2,0	233 06 120 015
	24,6	20,0		1,5 - 3,0	16,0	S=5,4-e	17,2	2,0	233 06 120 030
	26,2			3,0 - 4,5		S=7,0-e			233 06 120 045
	27,8			4,5 - 6,0		S=8,6-e			233 06 120 060

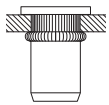

Stainless steel | Flat head | Knurled | Closed

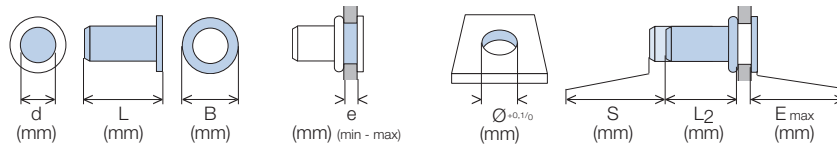

	d (mm)	L (mm)	B (mm)	e (mm) (min - max)	Ø ^{+0,10} (mm)	S (mm)	L ₂ (mm)	E max (mm)	
M3	13,6			0,7 - 1,5		S=2,4-e			233 26 030 015
	14,7	7,0		1,5 - 2,5	5,0	S=3,5-e	10,2	1,0	233 26 030 025
	15,4			2,3 - 3,2		S=4,4-e	10,1		233 26 030 032
M4	14,8	8,0		0,7 - 1,5	6,0	S=2,6-e		1,0	233 26 040 015
	16,2			0,7 - 3,0		S=4,8-e	11,2	1,0	233 26 040 030
	16,7			2,5 - 3,5		S=4,7-e			233 26 040 035
	17,5			2,5 - 4,2		S=5,5-e			233 26 040 042
M5	17,8	9,0		0,7 - 1,5	7,0	S=2,8-e		1,0	233 26 050 015
	19,3			1,5 - 3,0		S=4,5-e	14,0	1,0	233 26 050 030
	20,4			3,0 - 4,0		S=5,6-e	13,8		233 26 050 040
M6	18,3			0,8 - 1,5		S=3,1-e		1,5	233 26 060 015
	19,8	11,0		1,5 - 3,0	9,0	S=4,7-e	13,7	1,5	233 26 060 030
	21,4			3,0 - 4,5		S=6,3-e			233 26 060 045
	23,2			4,5 - 6,0		S=7,9-e			233 26 060 060
M8	21,3			0,8 - 1,5		S=3,2-e		1,5	233 26 080 015
	22,8	14,0		1,5 - 3,0	11,0	S=4,7-e	16,6	1,5	233 26 080 030
	24,4			3,0 - 4,5		S=6,3-e			233 26 080 045
	26,0			4,5 - 6,0		S=7,9-e			233 26 080 060
M10	27,8			0,8 - 1,5		S=3,9-e		2,0	233 26 100 015
	29,4	16,0		1,5 - 3,0	13,0	S=5,5-e	21,9	2,0	233 26 100 030
	31,0			3,0 - 4,5		S=7,1-e			233 26 100 045
	32,6			4,5 - 6,0		S=8,7-e			233 26 100 060
M12	32,0			0,8 - 1,5		S=3,8-e		2,0	233 26 120 015
	33,6	20,0		1,5 - 3,0	16,0	S=5,4-e	26,2	2,0	233 26 120 030
	35,2			3,0 - 4,5		S=7,0-e			233 26 120 045
	36,8			4,5 - 6,0		S=8,6-e			233 26 120 060

Stainless steel | Countersunk head | Knurled | Open

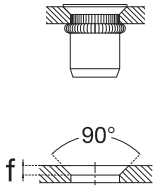
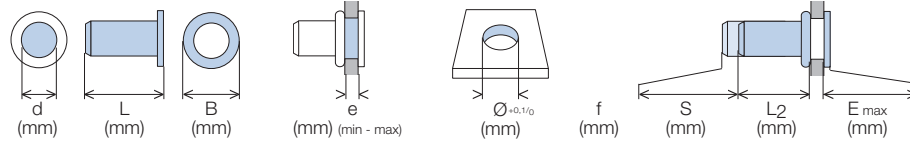

	d (mm)	L (mm)	B (mm)	e (mm) (min - max)	Ø ^{-0,1/0} (mm)	f (mm)	S (mm)	L ₂ (mm)	E _{max} (mm)	
M3	8,8	7,0		1,3 - 2,0	5,0	0,9	S=2,9-e	5,9	0,1	233 16 030 020
	9,9			2,0 - 3,0			S=4,0-e			233 16 030 030
M4	9,3	8,0		1,3 - 2,0	6,0	0,9	S=3,1-e	6,2	0,1	233 16 040 020
	10,3			2,0 - 3,0			S=4,1-e			233 16 040 030
M5	11,3	9,0		1,5 - 2,0	7,0	0,9	S=3,4-e	7,8	0,1	233 16 050 020
	12,3			2,0 - 3,0			S=4,5-e			233 16 050 030
M6	13,4	10,6		1,5 - 4,0	9,0	0,9	S=4,7-e	8,6	0,1	233 16 060 400
	15,4			4,0 - 5,0			S=6,9-e			233 16 060 050
M8	16,5	14,0		5,0 - 6,0	11,0	1,4	S=8,0-e	10,6	0,1	233 16 060 060
	15,3			1,5 - 3,0			S=4,7-e			233 16 080 030
M8	16,3	14,0		3,0 - 4,0	11,0	1,4	S=5,8-e	10,6	0,1	233 16 080 040
	17,4			4,0 - 5,0			S=6,9-e			233 16 080 050
M8	18,5	14,0		5,0 - 6,0	11,0	1,4	S=8,0-e	10,6	0,1	233 16 080 060
	19,4			1,5 - 3,0			S=5,5-e			233 16 100 030
M10	21,0	16,0		3,0 - 4,5	13,0	1,4	S=7,1-e	13,9	0,1	233 16 100 045
	22,6			4,5 - 6,0			S=8,7-e			233 16 100 060
M12	22,6	19,0		1,5 - 3,0	16,0	1,4	S=5,4-e	17,2	0,1	233 16 120 030
	24,2			3,0 - 4,5			S=7,0-e			233 16 120 045
	25,8	19,0		4,5 - 6,0	16,0	1,4	S=8,6-e	17,2	0,1	233 16 120 060

Stainless steel | Countersunk head | Knurled | Closed

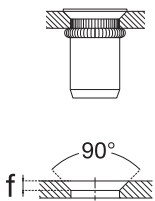
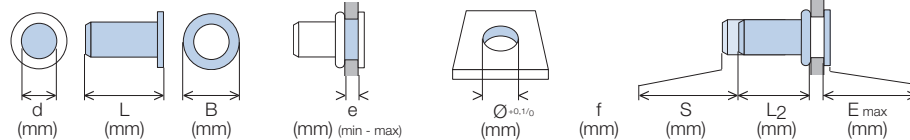

	d (mm)	L (mm)	B (mm)	e (mm) (min - max)	Ø ^{-0,1/0} (mm)	f (mm)	S (mm)	L ₂ (mm)	E _{max} (mm)	
M3	13,1	7,0		1,3 - 2,0	5,0	0,9	S=2,9-e	10,2	0,1	233 36 030 020
	14,2			2,0 - 3,0			S=4,0-e			233 36 030 030
M4	14,3	8,0		1,3 - 2,0	6,0	0,9	S=3,1-e	11,2	0,1	233 36 040 020
	15,3			2,0 - 3,0			S=4,1-e			233 36 040 030
M4	16,4	8,0		3,0 - 4,0	6,0	0,9	S=6,5-e	11,2	0,1	233 36 040 040
	17,3			1,5 - 2,0			S=3,4-e			233 36 050 020
M5	18,3	9,0		2,0 - 3,0	7,0	0,9	S=4,5-e	13,9	0,1	233 36 050 030
	19,4			3,0 - 4,0			S=5,6-e			233 36 050 040
M6	18,3	11,0		1,5 - 3,0	9,0	0,9	S=4,7-e	13,6	0,1	233 36 060 030
	19,3			3,0 - 4,0			S=5,8-e			233 36 060 040
M6	20,4	11,0		4,0 - 5,0	9,0	0,9	S=6,9-e	13,6	0,1	233 36 060 050
	21,5			5,0 - 6,0			S=8,0-e			233 36 060 060
M8	21,3	14,0		1,5 - 3,0	11,0	1,4	S=4,8-e	16,5	0,1	233 36 080 030
	22,3			3,0 - 4,0			S=5,8-e			233 36 080 040
M8	23,4	14,0		4,0 - 5,0	11,0	1,4	S=6,9-e	16,5	0,1	233 36 080 050
	24,5			5,0 - 6,0			S=8,0-e			233 36 080 060
M10	27,4	16,0		1,5 - 3,0	13,0	1,4	S=5,5-e	21,9	0,1	233 36 100 030
	29,0			3,0 - 4,5			S=7,1-e			233 36 100 045
	30,6	16,0		4,5 - 6,0	13,0	1,4	S=8,7-e	21,9	0,1	233 36 100 060

RIVKLE® – Standard blind rivet nuts - Stainless steel

Stainless steel | Countersunk head | Plain | Open

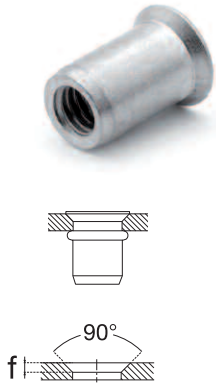

	d (mm)	L (mm)	B (mm)	e (mm) (min - max)	$\varnothing_{\pm 0,1/0}$ (mm)	f (mm)	S (mm)	L ₂ (mm)	E _{max} (mm)	
M4	11,3	7,6	1,30 - 2,50	6,0	1,3	S=4,4-e	6,8	0,1		233 18 040 250
	10,8	8,0	1,75 - 3,25	6,0	1,3	S=5,3-e	5,4			
M5	12,5	9,2	1,50 - 3,00	7,0	1,5	S=4,0-e	8,5	0,1		233 18 050 300
	13,8	9,6	3,00 - 4,00	7,0	1,5	S=5,4-e	8,4			
M6	14,8	11,3	1,50 - 3,00	9,0	1,5	S=4,9-e	9,5	0,1		233 18 060 300
	16,6	11,5	3,00 - 4,50	9,0	1,5	S=7,1-e	9,4			
	18,0	11,5	4,50 - 6,00	9,0	1,5	S=5,4-e	11,2			
M8	16,3	13,1	1,50 - 3,00	11,0	1,5	S=5,0-e	10,5	0,1		233 18 080 300
	18,1	13,5	3,00 - 4,50	11,0	1,5	S=5,9-e	11,1			
	19,7	13,5	4,50 - 6,00	11,0	1,5	S=8,2-e	11,4			
M10	20,2	15,5	1,50 - 3,00	13,0	1,5	S=5,2-e	14,7	0,1		233 18 100 300
	21,8	15,5	3,00 - 4,50	13,0	1,5	S=7,1-e	14,7			
	23,4	15,5	4,50 - 6,00	13,0	1,5	S=8,7-e	14,7			

Stainless steel | Thin head | Plain | Open



	d (mm)	L (mm)	B (mm)	e (mm) (min - max)	$\varnothing_{\pm 0,1/0}$ (mm)	S (mm)	L ₂ (mm)	E _{max} (mm)	
M3	8,8	5,3	0,5 - 1,5	4,7	S=2,8-e	5,5	0,4	343 08 030 150	
M4	10,4	7,0	0,5 - 2,0	6,4	S=3,5-e	7,3	0,5	343 08 040 200	
M5	11,6	7,7	0,5 - 3,0	7,1	S=5,0-e	7,3	0,6	343 08 050 300	
M6	14,3	10,2	0,7 - 3,0	9,5	S=5,5-e	9,3	0,6	343 08 060 300	
M8	16,35	11,3	0,7 - 3,0	10,5	S=6,1-e	10,5	0,7	343 08 080 300	

 For holes with imperial dimensions

Stainless steel | Flat head | Plain | Open



	d (mm)	L (mm)	B (mm)	e (mm) (min - max)	$\varnothing_{\pm 0,1/0}$ (mm)	S (mm)	L ₂ (mm)	E _{max} (mm)	
M4	12,0	9,0	0,5 - 2,0	6,0	S=3,5-e	7,8	1,0		233 08 040 020
	13,5	9,0	2,0 - 3,5	6,0	S=5,2-e	7,8			
M5	12,5	10,0	0,5 - 3,0	7,0	S=4,7-e	7,7	1,0		233 08 050 030
	14,3	9,0	3,0 - 4,0	7,0	S=5,6-e	7,7			
M6	16,0	12,0	0,5 - 3,0	9,0	S=6,0-e	10,0	1,5		233 08 060 300
	18,0	12,0	3,0 - 5,0	9,0	S=7,75-e	7,8			
M8	16,5	14,0	0,8 - 3,0	11,0	S=4,7-e	9,5	1,5		233 08 080 300
	19,4	14,0	3,0 - 4,5	11,0	S=7,0-e	10,9			
M10	22,4	16,0	1,0 - 3,0	13,0	S=5,6-e	14,9	2,0		233 08 100 300
	24,0	16,0	3,0 - 4,5	13,0	S=7,2-e	15,1			
	25,6	16,0	4,5 - 6,0	13,0	S=8,8-e	14,9			

RIVKLE® – Standard blind rivet nuts - Stainless steel A4

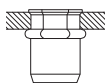

Stainless steel A4 | Thin head | Semi-hexagonal | Open

	(mm)	(mm)	(mm)	(mm) (min - max)	(mm)		(mm)	(mm)	
M4	11,0	6,5		0,5 - 2,0	6,0	9 500	7,5	0,5	343 44 040 020
M5	12,0	7,5			7,0	12 000	7,2		343 44 050 030
M6	14,5	9,7		0,5 - 3,0	9,0	15 000	9,3		343 44 060 030
M8	16,0	11,5			11,0	20 000	11,0		343 44 080 030

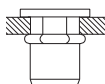

Stainless steel A4 | Flat head | Semi-hexagonal | Open

	(mm)	(mm)	(mm)	(mm) (min - max)	(mm)		(mm)	(mm)	
M4	11,0	9,0		0,5 - 2,0	6,0	9 500	7,5	1,0	233 44 040 020
M5	12,5	10,0			7,0	12 000	7,2	1,5	233 44 050 030
M6	16,0	12,0		0,5 - 3,0	9,0	15 000	9,3		233 44 060 030
M8	17,5	15,0			11,0	20 000	11,0		233 44 080 030



Stainless steel A4 | Thin head | Plain | Open

	(mm)	(mm)	(mm)	(mm) (min - max)	(mm)		(mm)	(mm)	
M5	12,0	7,5		0,5 - 3,0	7,0	12 000	7,2	0,4	343 64 050 030
M6	14,5	9,5			9,0	15 000	9,4		343 64 060 030
M8	16,0	11,5			11,0	20 000	11,2		343 64 080 030

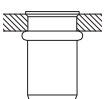

Stainless steel A4 | Thin head | Plain | Closed

	(mm)	(mm)	(mm)	(mm) (min - max)	(mm)		(mm)	(mm)	
M4	15,5	6,5		0,5 - 2,0	6,0	9 500	11,6	0,5	343 74 040 020
M5	18,0	7,5			7,0	12 000	13,2		343 74 050 030
M6	21,5	9,5		0,5 - 3,0	9,0	15 000	16,7		343 74 060 030
M8	24,0	11,5			11,0	20 000	19,2		343 74 080 030



Range dedicated to industry use. In case of non metallic support, please contact us.

RIVKLE® – Standard blind rivet nuts - Stainless steel A4

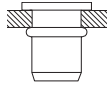

Stainless steel A4 | Thin head | Plain | Open

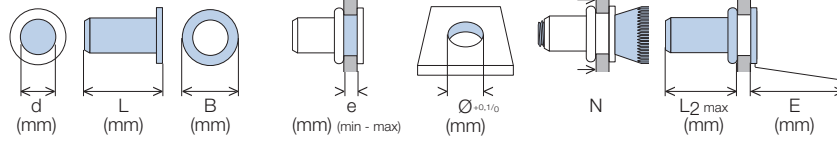

	d (mm)	L (mm)	B (mm)	e (mm) (min - max)	Ø ^{+0.1/0} (mm)	N	L ₂ max (mm)	E (mm)	
M4	12,0	12,0	9,0	0,5 - 2,0	6,0	9 500	7,5	1,0	233 04 040 020
M5	12,5	12,5	10,0	0,5 - 3,0	7,0	12 000	7,5	1,5	233 04 050 030
M6	16,0	16,0	12,0		9,0	15 000	10,0		233 04 060 030
M8	17,5	17,5	15,0		11,0	20 000	11,2		233 04 080 030

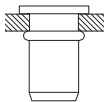

Stainless steel A4 | Thin head | Plain | Closed

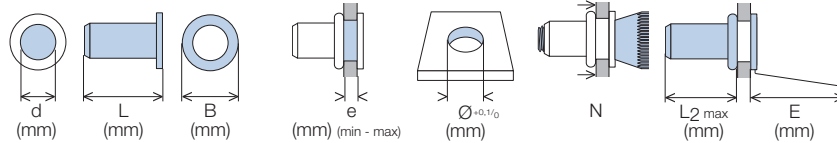







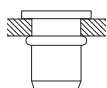

	d (mm)	L (mm)	B (mm)	e (mm) (min - max)	Ø ^{+0.1/0} (mm)	N	L ₂ max (mm)	E (mm)	
M4	16,0	16,0	9,0	0,5 - 2,0	6,0	9 500	11,5	1,0	233 24 040 020
M5	18,5	18,5	10,0	0,5 - 3,0	7,0	12 000	13,2	1,5	233 24 050 030
M6	23,0	23,0	12,0		9,0	15 000	17,0		233 24 060 030
M8	25,0	25,0	15,0		11,0	20 000	18,7		233 24 080 030

Range dedicated to industry use. In case of non metallic support, please contact us.

RIVKLE® – Standard blind rivet nuts – Aluminium







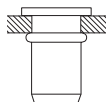



Aluminium | Thin head | Plain | Open

	 d (mm)	 L (mm)	 B (mm)	 e (mm) (min - max)	 Ø ^{+0,1/0} (mm)	 S (mm)	 L ₂ (mm)	 E (mm)	
M3	10,5	8,0	0,50 - 2,00	5,0	S=3,2-e	5,4	0,75	233 00 030 020	
	10,75	7,5	2,00 - 3,50		S=4,3-e		1,0	233 00 030 035	
M4	11,0	9,0	0,25 - 2,50	6,0	S=4,1-e	6,3	1,0	233 00 040 025	
	13,0	10,0	3,00 - 4,50		S=5,9-e	6,4	0,75	233 00 040 046	
M5	13,6	10,0	0,50 - 3,00	7,0	S=4,5-e	7,8	1,0	233 00 050 030	
	16,0	11,0	3,00 - 5,50		S=6,7-e	8,3		233 00 050 056	
M6	16,6	13,0	0,50 - 3,00	9,0	S=5,0-e	10,4	1,5	233 00 060 030	
	18,0		3,00 - 5,50		S=6,8-e	9,7		233 00 060 056	
M8	20,0	16,0	0,50 - 3,00	11,0	S=5,8-e	12,7	1,5	233 00 080 030	
	20,0		3,00 - 5,50		S=7,2-e	11,3		233 00 080 056	
M10	25,0	19,0	0,80 - 3,50	13,0	S=6,2-e	16,8	2,0	233 00 100 035	
	27,7		3,50 - 6,00		S=8,7-e	17,0		233 00 100 060	



Aluminium | Thin head | Plain | Closed

	 d (mm)	 L (mm)	 B (mm)	 e (mm) (min - max)	 Ø ^{+0,1/0} (mm)	 S (mm)	 L ₂ (mm)	 E (mm)	
M3	13,5	7,5	0,25 - 2,00	5,0	S=3,0-e	9,3	1,0	233 20 030 020	
	15,1		2,00 - 3,50		S=4,3-e	9,8		233 20 030 035	
M4	15,5	10,0	0,50 - 3,00	6,0	S=4,0-e	10,8	0,75	233 20 040 030	
	18,1	9,0	2,50 - 4,50		S=5,6-e	11,5	1,0	233 20 040 045	
M5	19,0	11,0	0,50 - 3,00	7,0	S=4,5-e	13,5	1,0	233 20 050 031	
	21,9	10,0	3,00 - 5,50		S=6,9-e	14,0		233 20 050 055	
M6	23,0	13,0	0,50 - 3,00	9,0	S=4,5-e	17,3	1,5	233 20 060 031	
	26,3		3,00 - 5,50		S=7,7-e	17,1		233 20 060 055	
M8	24,0	16,0	0,50 - 3,00	11,0	S=4,5-e	18,0	1,5	233 20 080 031	
	31,0		3,00 - 5,50		S=8,5-e	21,0		233 20 080 055	
M10	37,5	19,0	3,50 - 6,00	13,0	S=9,0-e	26,5	2,0	233 20 100 060	

If you need aluminium nuts with high mechanical strength, a **RIVKLE® HRT** version is available. See page 41.

RIVKLE® – Standard blind rivet nuts – Aluminium

Aluminium | Countersunk head | Plain | Open



	d (mm)	L (mm)	B (mm)	e (mm) (min - max)	$\varnothing^{+0.1/0}$ (mm)	f (mm)	S (mm)	L ₂ (mm)	E _{max} (mm)	
M3	10,2	10,2	7,2	1,3 - 3,5	5,0	1,3	S=4,0-e	6,1	0,1	233 10 030 035
	11,8	11,8	7,2	3,5 - 5,0	5,0	1,3	S=6,0-e	5,7		233 10 030 050
M4	11,5	11,5	9,0	1,7 - 3,5	6,0	1,5	S=4,4-e	6,7	0,1	233 10 040 036
	12,8	12,8	8,2	3,5 - 5,0	6,0	1,3	S=6,0-e			233 10 040 050
M5	13,0	13,0	10,0	1,0 - 4,0	7,0	0,9	S=5,5-e	7,8	0,1	233 10 050 040
	16,3	16,3	9,6	4,0 - 6,5	7,0	1,5	S=7,7-e			8,5
M6	17,0	17,0	12,0	1,7 - 4,5	9,0	1,5	S=6,3-e	10,4	0,1	233 10 060 046
	18,7	18,7	11,7	4,5 - 6,5	9,0	1,5	S=8,7-e			9,9
M8	19,0	19,0	14,0	1,7 - 4,5	11,0	1,5	S=7,5-e	12,7	0,1	233 10 080 046
	22,2	22,2	13,5	4,5 - 6,5	11,0	1,5	S=9,3-e			12,8
M10	21,0	21,0	15,4	1,7 - 4,5	12,5	1,5	S=7,5-e	13,2	0,1	233 10 100 046
	26,1	26,1	15,5	4,5 - 6,5	13,0	1,5	S=10,4-e			17,0

Aluminium | Countersunk head | Plain | Closed



	d (mm)	L (mm)	B (mm)	e (mm) (min - max)	$\varnothing^{+0.1/0}$ (mm)	f (mm)	S (mm)	L ₂ (mm)	E _{max} (mm)	
M3	14,1	14,1	7,2	1,5 - 3,5	5,0	1,3	S=4,0-e	10,0	0,1	233 30 030 035
	17,7	17,7	7,2	1,5 - 3,5	5,0	1,3	S=4,6-e	11,6		233 30 040 035
M4	19,3	19,3	8,2	3,5 - 5,0	6,0	1,3	S=6,0-e	11,8	0,1	233 30 040 050
	19,4	19,4	9,6	1,5 - 4,5	7,0	1,5	S=5,7-e	13,6		233 30 050 045
M6	25,2	25,2	11,7	1,5 - 4,5	9,0	1,5	S=6,5-e	17,0	0,1	233 30 060 045
	27,3	27,3	11,7	4,5 - 6,5	9,0	1,5	S=8,6-e			233 30 060 065
M8	30,0	30,0	13,5	1,5 - 4,5	11,0	1,5	S=6,9-e	21,4	0,1	233 30 080 045
	32,1	32,1	13,5	4,5 - 6,5	11,0	1,5	S=9,1-e			21,3
M10	33,9	33,9	15,5	1,5 - 4,5	13,0	1,5	S=7,5-e	26,5	0,1	233 30 100 045

If you need aluminium nuts with high mechanical strength, a **RIVKLE® HRT** version is available. See page 41.

RIVKLE® – Standard blind rivet studs - Steel

Advantages

- Allows you to hold the part to be screwed onto the stud in position (vertical installation, heavy or bulky part, etc.)
- Creates a reusable thread equivalent to a Class 8.8 bolt
- Keep enjoying the advantages of a simple and quick installation process with access from only one side

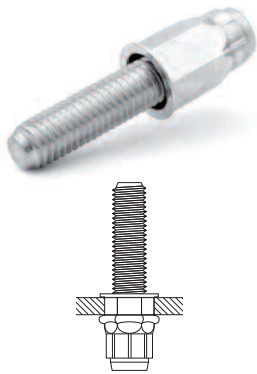

Steel | Thin head | Hexagonal

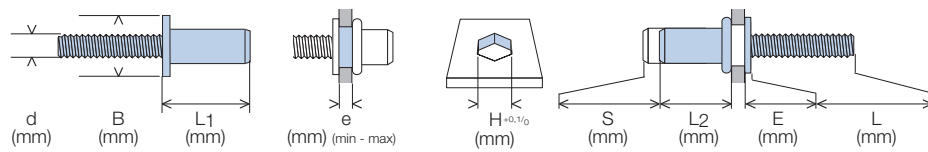

M8	10,0	15,8	0,5 - 3,0	9,0	S=5,5-e	8,0	0,45	21,0 - 25,5	372 91 080 527
		13,5	20,2	3,0 - 5,5	11,0	S=8,0-e	11,7	0,5	28,0 - 32,0

Steel | Flat head | Hexagonal

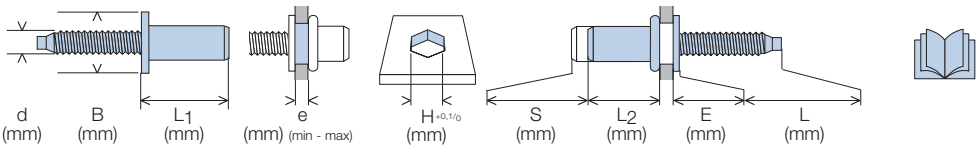

M5	10,0	12,0	0,5 - 3,0	7,0	S=4,4-e	7,0	1,0	11,5 - 16,0	372 59 050 501*	1	2
									16,5 - 21,0	372 91 060 506	
M6	13,0	14,3	0,5 - 3,0	9,0	S=4,8-e	8,0	1,5	12,5 - 17,0	372 91 060 517*		✓
								18,5 - 23,0	372 91 060 509		✓
								27,5 - 32,0	372 91 060 502		✓
M8	16,0	15,5	0,5 - 3,0	11,0	S=5,8-e	9,0	1,5	19,0 - 23,0	372 91 080 502		✓
								28,5 - 33,0	372 91 080 507		✓
								37,2 - 41,6	372 91 080 510		✓

* references without dog point

Coating: 1 = Zn8K+/Fe ; 2 = ZnNi8A/Fe

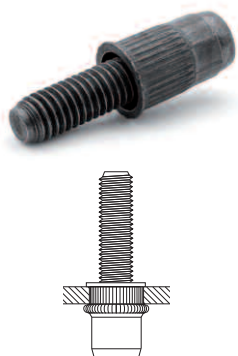

Steel | Thin head | Knurled

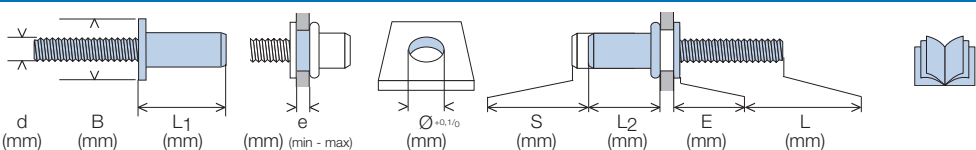

M6	10,0	15,3	1,0 - 4,0	9,0	S=5,7-e	8,95	0,6	15,4 - 20,4	372 97 060 518	1	2
									11,4 - 16,4	372 97 060 519	
M8	12,0	17,5	1,0 - 4,0	11,0	S=7,0-e	9,5	0,6	14,5 - 19,5	372 97 080 505		✓
								22,0 - 27,0	372 97 080 507		✓
								22,4 - 27,4	372 97 080 510		✓

Coating: 1 = Zn8K+/Fe ; 2 = ZnNi8A/Fe

RIVKLE® – Standard blind rivet studs - Steel

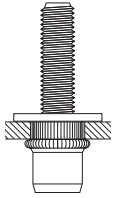

Steel | Flat head | Knurled

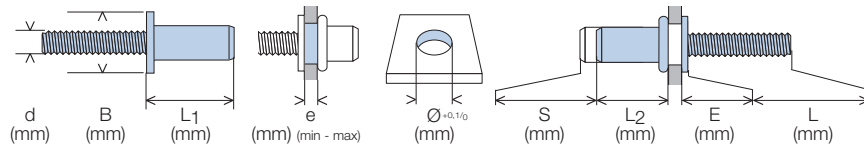

	d (mm)	B (mm)	L1 (mm)	e (mm) (min - max)	Ø ^{+0.1/0} (mm)	S (mm)	L2 (mm)	E (mm)	L (mm)		1	2
M5	10,0	11,2	0,5 - 3,0	7,0	S=5,0-e	5,0	1,0	7,5 - 12,0	372 27 050 110	✓		
								12,5 - 17,0	372 27 050 115 ^s	✓		
								17,5 - 22,0	372 27 050 120 ^s	✓		
								22,5 - 27,0	372 27 050 125	✓		
M6	13,0	14,2	0,5 - 3,0	9,0	S=5,2-e	8,5	1,5	14,0 - 18,5	372 27 060 115 ^s	✓		
		16,9	3,0 - 5,5					S=7,7-e	14,0 - 18,5	372 29 060 504	✓	
		14,2	0,5 - 3,0					S=5,2-e	19,0 - 23,5	372 27 060 120 ^s	✓	
		14,2	0,5 - 3,0					S=5,2-e	24,0 - 28,5	372 27 060 125	✓	
M8	16,0	15,6	0,5 - 3,0	11,0	S=5,7-e	8,5	1,5	13,5 - 18,0	372 27 080 115	✓		
		15,6	0,5 - 3,0					S=5,7-e	18,5 - 23,0	372 27 080 120	✓	
		18,3	3,0 - 5,5					S=7,6-e	18,0 - 22,5	372 29 080 506 ^s	✓	
		15,6	0,5 - 3,0					S=5,7-e	23,5 - 28,0	372 27 080 125	✓	

s : parts available from stock, package quantity 250 pieces.

Revêtement 1 = Zn8K+/Fe ; 2 = ZnNi8A/Fe

With their inclined thread, the RIVKLE® studs allow you to attach snap-on clips without tools.

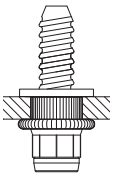

Steel | Flat head | Fir Tree studs

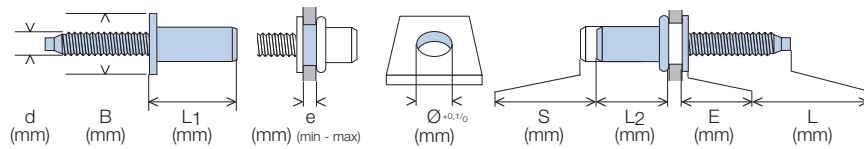

	d (mm)	B (mm)	L1 (mm)	e (mm) (min - max)	Ø ^{+0.1/0} (mm)	S (mm)	L2 (mm)	E (mm)	L (mm)		1	2
D5	10,0	10,2	0,5 - 3,0	7,0	S=4,8-e	5,5	1,0	12,0 - 16,5	372 97 059 505		✓	
		10,2	0,5 - 3,0					S=4,8-e	14,5 - 19,0	372 97 059 507	✓	
		11,6	1,5 - 4,0					S=5,7-e	14,0 - 18,5	372 97 059 508	✓	
D6	13,0	12,7	0,5 - 3,0	9,0	S=4,8-e	8,0	1,5	19,0 - 23,5	372 97 069 501	✓		
		12,7	0,5 - 3,0					S=4,8-e	14,0 - 18,5	372 97 069 502	✓	
		12,7	0,5 - 3,0					S=4,8-e	11,5 - 16,0	372 97 069 503	✓	
		12,7	0,5 - 3,0					S=4,8-e	21,5 - 26,0	372 97 069 507	✓	
		15,4	3,0 - 5,5					S=7,7-e	11,5 - 16,0	372 97 069 504	✓	
		15,4	3,0 - 5,5					S=7,7-e	14,0 - 18,5	372 97 069 505	✓	
15,4	3,0 - 5,5	S=7,7-e	19,0 - 23,5	372 97 069 506	✓							

Revêtement 1 = Zn8K+/Fe ; 2 = ZnNi8A/Fe

RIVKLE® – Standard blind rivet studs - Stainless steel

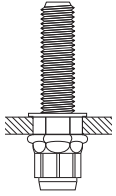

Stainless steel | Thin head | Hexagonal

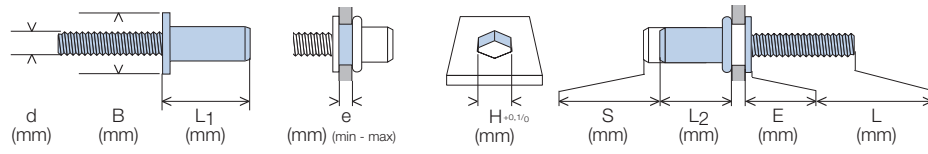

M5	10,0	13,35	0,5 - 3,0	7,0	S=4,4-e	8,5	0,5	15,5 - 18,0	372 98 050 502
								20,5 - 23,0	372 98 050 503
								25,5 - 28,0	372 98 050 504
M6	13,0	15,65	0,5 - 3,0	9,0	S=4,4-e	10,8	0,5	15,5 - 18,0	372 98 060 506
								20,5 - 23,0	372 98 060 507
								25,5 - 28,0	372 98 060 508

All RIVKLE® stainless steel studs are lubricated.

RIVKLE®

PRODUCT VARIANTS



	Page
General presentation of the RIVKLE® product line	
An optimized assembly solution for improved performance	4
The RIVKLE® technology	6
Setting of RIVKLE® fasteners	7
Material and surface treatment	9
Selection of the nut or stud	10
Additional services	12
Legend	13
The standard RIVKLE® line	
Blind rivet nuts	16
Blind rivet studs	35
RIVKLE® product variants	
HRT nuts - High Resistance Thread	40
SFC nuts and studs - For fiber-reinforced polymer	42
PN nuts - Ultimate pull-out force	44
Seal Ring nuts and studs and other watertight solutions	46
The RIVKLE® setting tools	
Hand operated assembly tools	50
Hydropneumatic and battery-powered setting tools	53
Special installation machines	61
BÖLLHOFF is the only supplier for your assembly components and associated tools	
Part number index	64

For absolute robustness

High strength and reduced dimensions for your structural assemblies.

This blind rivet nut was designed to provide high-strength female threads after setting while retaining optimum dimensions.



Advantages

- Extend the use of blind rivet nuts to applications involving high mechanical stresses.
- Add high-strength female threads to complex parts allowing access from only one side.
- In its aluminium version, this rivet nut provides full compatibility with class 8.8 screws.

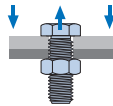
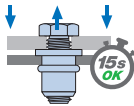

Permissible loads

	Ø	Permissible loads (N)		
		10.9 (ISO 898-1)	10 (ISO 898-2)	HRT
Steel 10.9	M6	16 700 N	20 900 N	20 900 N
	M8	30 400 N	38 100 N	38 100 N
	M10	48 100 N	60 300 N	60 300 N
	M12	70 000 N	88 500 N	88 500 N
Steel 12.9	M6	19 500 N	23 100 N	23 100 N
	M8	35 500 N	42 500 N	42 500 N
	M10	56 300 N	67 300 N	67 300 N
	M12	81 800 N	100 300 N	100 300 N
Aluminium	M5	8 230 N	12 140 N	12 140 N
	M6	11 600 N	17 200 N	17 200 N
	M8	21 200 N	31 800 N	31 800 N

RIVKLE® HRT - Steel

Steel HRT | Flat head | Hexagonal | Open

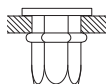

	d (mm)	L (mm)	B (mm)	e (mm) (min - max)	H ^{+0,1/0} (mm)	S (mm)	L ₂ (mm)	E (mm)		10.9	12.9
M6	20,0	14,0		1,0 - 3,0	9,0	S=6,5-e	13,0	1,5	232 91 060 502	✓	-
M8	23,6	17,0		1,0 - 3,0	11,0	S=6,3-e	16,0	1,5	232 91 080 504	✓	-
	26,6		3,0 - 6,0	S=9,6-e		232 49 080 502			✓	✓	
M10	27,0	20,0		1,0 - 3,5	13,0	S=8,7-e	17,5	2,0	232 91 100 503	✓	✓
	28,5	24,0	2,0 - 5,0	S=9,5-e		18,0	232 91 100 501		✓	✓	
M12x1,5	33,0	27,0		1,0 - 4,0	16,0	S=10,5-e	22,0	2,0	232 91 124 501	✓	✓

A wide range of plating finishes are available. Other configurations are available upon request.

Setting forces*

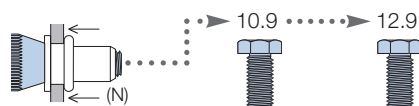

M6	232 91 060 502	14 000	-
M8	232 91 080 504	24 000	-
	232 49 080 502	24 000	27 000
M10	232 91 100 503	38 000	42 000
	232 91 100 501	38 000	42 000
M12x1,5	232 91 124 501	55 000	61 000

*The recommended setting force depends on the characteristics of the assembly.

To prevent any re-setting of the RIVKLE® HRT fastener during the installation of the bolt, we recommend to apply a setting load in accordance with the tension applied to the bolt.

In certain cases, it is possible to reduce these loads, contact BÖLLHOFF to obtain further information.

RIVKLE® HRT - Aluminum

Aluminium HRT | Flat head | Hexagonal | Open

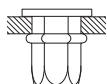

	d (mm)	L (mm)	B (mm)	e (mm) (min - max)	H ^{+0,1/0} (mm)	S (mm)	L ₂ (mm)	E (mm)		8.8
M5	18,1	14,0		0,5 - 3,0	7,0	S=6,5-e	11,0	1,0	232 90 050 501	✓
M6	18,6	14,0		0,5 - 3,0	9,0	S=6,8-e	11,5	1,5	232 40 060 030	✓
M8	23,6	17,0		0,5 - 3,5	11,0	S=7,0-e	15,5	1,5	232 40 080 030	✓

Optimized for aluminium and magnesium workpieces.

Weight saving and corrosion resistant solutions for external applications.

Setting forces*

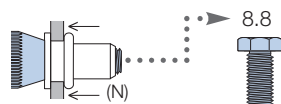

M5	232 90 050 501	12 000
M6	232 40 060 030	12 000
M8	232 40 080 030	18 000

The key to light assemblies

An advantage for weight saving in vehicles

This rivet nut adds a high-strength female thread in polymer materials without causing damage to the application material. RIVKLE® SFC is suitable for flexible and brittle materials and can be integrated into any plastic parts without the need for particular precautions. After setting, thanks to its specific deformation, the bulge ensures uniform distribution of the grip forces.



Advantages

- Make simpler designs without worrying about the edge distances of your parts
- Use wider tolerances when drilling the holes (relief angle, etc.)
- No more constraints regarding the compatibility between the materials and the assembly components

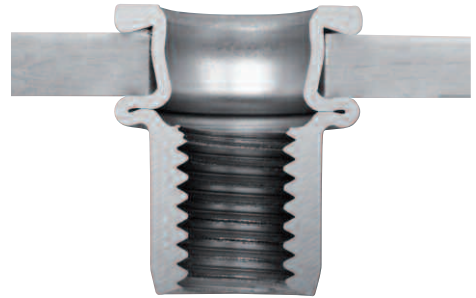

Permissible loads

M6	12 000 N	RIVKLE® reusable*	15 000 N
M8	18 000 N	RIVKLE® reusable*	27 000 N
Similar performance to standard RIVKLE®			

*RIVKLE® is more resistant than screw property class 8.8

RIVKLE® SFC - Steel



Steel | Flat head | Open

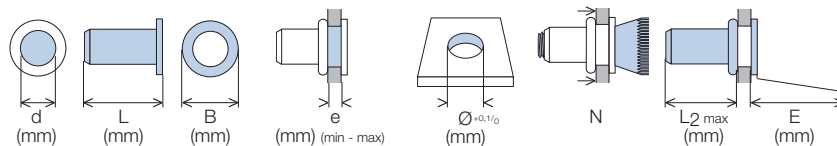

M5	16,1	16,0	2,0 - 3,5	8,1	8 000	8,0	1,0	233 91 050 795
	17,6		3,5 - 5,0					233 91 050 796
M6	20,7	13,0	2,0 - 3,5	9,1	12 000	11,0	1,5	233 91 060 968
	22,2		3,5 - 5,0					233 91 060 971
	20,7		2,0 - 3,5					233 91 060 969
M8	22,2	18,0	3,5 - 5,0	11,1	18 000	12,0	1,5	233 91 060 970
	22,0		2,0 - 3,5					233 91 080 848
	23,5		3,5 - 5,0					233 91 080 849



Steel | Elliptic head | Open

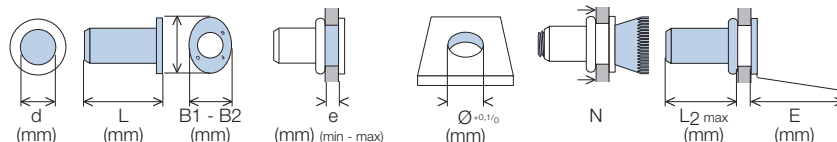

M6	20,9	17	13	2,2 - 3,7	9,2	12 000	11,5	1,7	233 91 060 995
-----------	------	----	----	-----------	-----	--------	------	-----	-----------------------



Steel | Flat head | Knurled

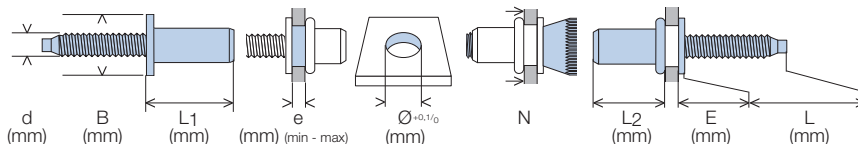

M6	18,0	19,8	2,0 - 3,5	9,1	11 600	13,0	1,5	25,0 - 28,0	372 91 060 522	✓
		18,3						16,5 - 19,5	372 91 060 525	✓

Coating: ❶ = Zn8K+/Fe ; ❷ = ZnNi8A/Fe

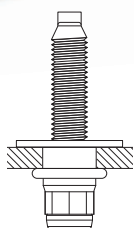

RIVKLE® SFC is fully compatible with the whole **BÖLLHOFF RIVKLE®** setting tool range (including fully automatic installation for mass production).

Available in alternative configurations upon request (stud, underhead seal, etc.).

Grip range could be increased in certain specific conditions when associated with substrate material in these cases a prototype validation will be necessary. (Please contact us).

The universal solution for supports with extreme variations

Extreme versatility in terms of thickness and diameter

The main difference of this RIVKLE® fastener is its slotted body which allows a petal-shaped deformation during the setting operation, thereby forming a large-size abutment. Its specific design allows it to accept large variations of the thickness of the support and/or variations of the diameter of the hole.



Advantages

- A great number of applications can be covered with a single product.
- You can counterbalance the variations of thickness and hole diameter which result from your process (plastic parts, plies, etc.).
- Secure your assemblies on thin plates or soft materials thanks to a large-size abutment.

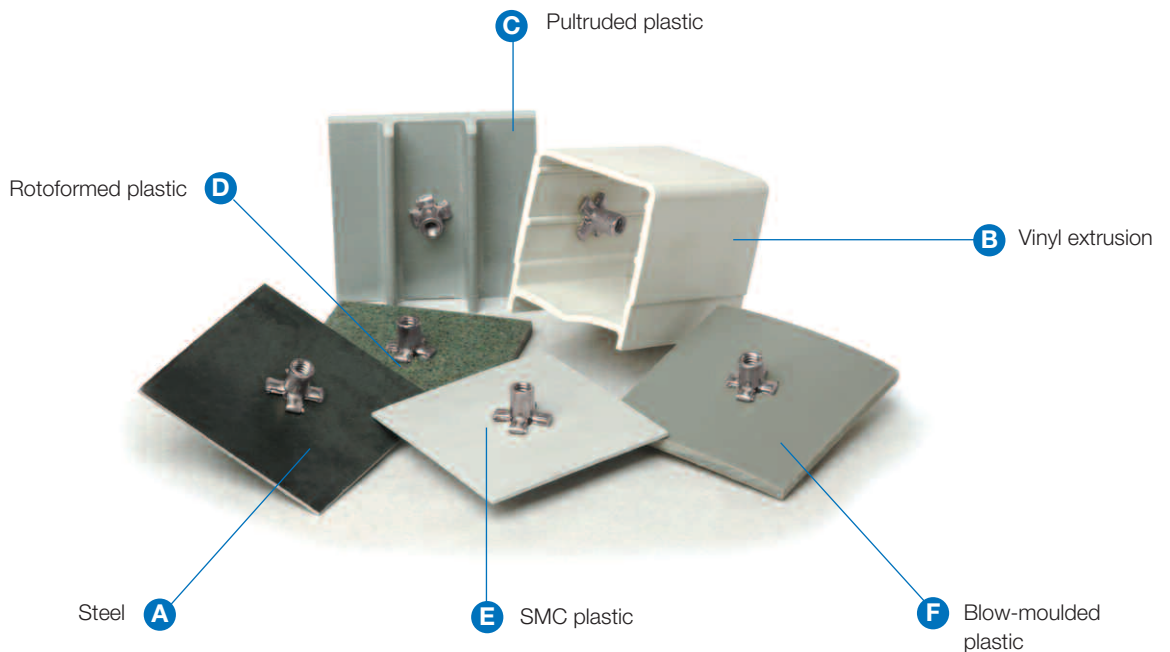

Mechanical performance

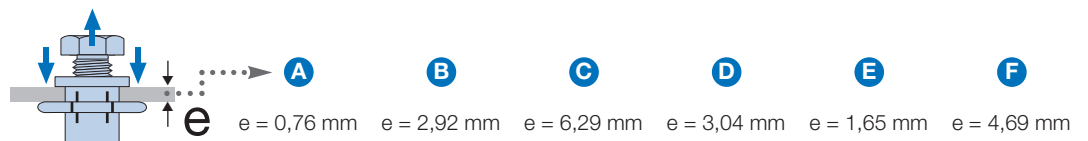

RIVKLE® M6	2 130 N	900 N	6 760 N	100 N	600 N	1 250 N
RIVKLE® PN M6	5 400 N	2 750 N	8 400 N	700 N	1 620 N	3 220 N

Test according to BÖLLHOFF specifications.

RIVKLE® PNP

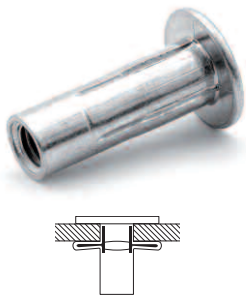

Steel | Flat head | Slotted | Open

	d (mm)	L (mm)	B (mm)	e (mm) (min - max)	D (mm)	Ø MIN (mm)	Ø MAX (mm)	L2 max (mm)	E (mm)	
M5	22,0	22,0	12,7	0,5 - 3,0	7,47	7,48	7,62	9,9	1,0	668 70 511 030
M6	26,9	26,9	15,9	0,5 - 5,0	8,79	8,80	8,93	12,8	1,5	668 70 611 050
M8	30,5	30,5	19,0	0,5 - 5,0	11,10	11,11	11,50	14,5	1,5	668 70 811 050

RIVKLE® PNC - Extended Grip Range



Steel | Flat head | Slotted | Open

	d (mm)	L (mm)	B (mm)	e (mm) (min - max)	D (mm)	Ø MIN (mm)	Ø MAX (mm)	L2 max (mm)	E (mm)	
M4	17,6	17,6	11,15	0,50 - 3,80	6,12	6,13	6,25	8,6	0,95	668 30 411 038
M5	21,95	21,95	12,7	0,50 - 4,45	7,47	7,48	7,58	9,9	0,95	668 30 511 044
	23,8	23,8		4,45 - 8,10	7,97					668 30 511 081
M6	26,9	26,9	15,9	0,50 - 7,10	8,79	8,80	8,90	12,8	1,50	668 30 611 071
	32,8	32,8		7,10 - 12,7						668 30 611 127
M8	30,5	30,5	19,0	0,50 - 7,10	11,10	11,11	11,50	14,5	1,57	668 30 811 071
M10	33,2	33,2	22,25	0,50 - 7,10	13,06	13,07	13,26	15,8	2,25	668 31 011 071

RIVKLE® PN - Stainless steel

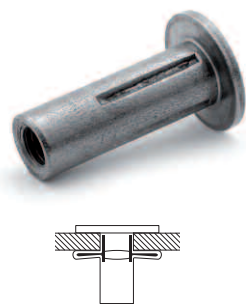

Stainless steel | Flat head | Slotted | Open

	d (mm)	L (mm)	B (mm)	e (mm) (min - max)	D (mm)	Ø MIN (mm)	Ø MAX (mm)	L2 max (mm)	E (mm)	
M4	17,6	17,6	11,1	0,50 - 3,80	6,12	6,13	6,25	8,6	0,96	668 30 488 038
M5	22,0	22,0	12,7	0,50 - 4,45	7,47	7,48	7,58	9,9	0,95	668 30 588 044
	23,8	23,8		4,45 - 8,10	7,97					668 30 588 081*
M6	26,9	26,9	15,9	0,50 - 7,10	8,79	8,80	8,90	12,8	1,50	668 30 688 071
	32,8	32,8		7,10 - 12,7						668 30 688 127*
M8	30,5	30,5	19,0	0,50 - 7,10	11,10	11,11	11,50	14,5	1,50	668 30 888 071
M10	33,2	33,2	22,2	0,50 - 7,10	13,06	13,07	13,26	15,8	2,24	668 31 088 071*

*Item not in stock – please contact BÖLLHOFF for availability

RIVKLE® PN - Tooling

Please use dedicated tooling, see page 58.

Tightness in all circumstances

Preserve your assemblies from external influences.

This insert leaves no room for compromise and ensures sealing against all fluids while retaining the performance of RIVKLE® over time (metal-to-metal contact). All our products are proof tested with air pressure in accordance with stringent process (ATEQ) and comply with the highest demands from automotive industry.



Advantages

- Simplify your sealed assemblies with a solution directly integrated into your RIVKLE® nuts or studs.
- Ensure systematic and repeatable sealing and preserve the mechanical performance of your assemblies.
- Keep enjoying the advantages of a simple and quick installation process with access from only one side. Compatible with all BÖLLHOFF setting tools, including for automatic blow-feed installation*.



*The fluid tightness properties of the product require compliance with the specified setting conditions, both in terms of equipment and support.
(For more information about the setting conditions, refer to page 8 and/or contact BÖLLHOFF).

New

RIVKLE® Seal Ring - Steel







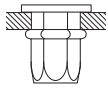

The **RIVKLE® Seal Ring** range is available with NBR seals for temperature stability from -30°C to +100°C.

The **RIVKLE® Seal Ring** range is also available with FKM seals for a temperature stability from -15°C to +220°C (cataphoresis passage).

On request, please contact BÖLLHOFF.







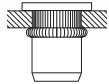



Steel | Flat head | Hexagonal | Closed

									
	d (mm)	L (mm)	B (mm)	e (mm) (min - max)	H ^{+0.1/0} (mm)	S (mm)	L ₂ (mm)	E _{max} (mm)	
M5	19,2	19,2	13,0	0,8 - 3,0	7,0	S=5,0-e	13,0	1,5	233 91 050 807
	21,4	21,4	13,0	2,5 - 5,0	7,0	S=7,1-e	13,0	1,5	233 91 050 808
M6	22,0	22,0	15,0	0,8 - 3,0	9,0	S=4,6-e	16,5	1,5	233 91 060 026
	24,2	24,2	15,0	2,5 - 5,0	9,0	S=6,9-e	16,5	1,5	233 91 060 027
M8	26,5	26,5	18,0	0,8 - 3,0	11,0	S=5,5-e	19,8	1,5	233 91 080 875
	28,7	28,7	18,0	2,5 - 5,0	11,0	S=7,7-e	19,8	1,5	233 91 080 876







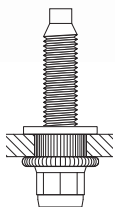



Steel | Flat head | Knurled | Closed

									
	d (mm)	L (mm)	B (mm)	e (mm) (min - max)	Ø ^{+0.1/0} (mm)	S (mm)	L ₂ (mm)	E _{max} (mm)	
M5	19,3	19,3	12,0	0,5 - 3,0	8,0	S=4,1-e	14,8	1,5	233 97 050 693
	21,5	21,5	12,0	2,5 - 5,0	8,0	S=6,2-e	14,8	1,5	233 97 050 694
M6	22,3	22,3	13,0	0,8 - 3,0	9,0	S=4,3-e	16,5	1,5	233 97 060 813
	24,5	24,5	13,0	2,5 - 5,0	9,0	S=6,5-e	16,5	1,5	233 97 060 814
M8	26,6	26,6	16,0	0,8 - 3,0	11,0	S=4,8-e	19,8	1,5	233 97 080 757
	28,5	28,5	16,0	2,5 - 5,0	11,0	S=7,1-e	19,9	1,5	233 97 080 758



Steel | Flat head | Knurled







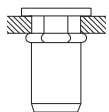

										
	d (mm)	B (mm)	L ₁ (mm)	e (mm) (min - max)	Ø ^{+0.1/0} (mm)	S (mm)	L ₂ (mm)	E (mm)	L (mm)	
M6	13,0	13,0	13,0	0,8 - 3,0	9,0	S=4,8-e	9,0	1,5	16,3 - 20,8	372 97 060 537

Sealed RIVKLE® - Stainless steel

For applications in the industrial sector, BÖLLHOFF also offers a new range of sealed stainless steel fasteners with O-ring seals.



Stainless steel | Flat head | Semi-hexagonal | Closed

									
	d (mm)	L (mm)	B (mm)	e (mm) (min - max)	H ^{+0.1/0} (mm)	S (mm)	L ₂ (mm)	E _{max} (mm)	
M5	19,0	19,0	13,5	0,5 - 3,0	7,0	4,6-e	14,4	1,5	233 94 050 504
	20,5	20,5	13,5	3,0 - 4,5	7,0	5,9-e	14,6	1,5	233 94 050 505
M6	21,5	21,5	16,0	0,5 - 3,0	9,0	5,5-e	16,0	1,5	233 94 060 599
	24,4	24,4	16,0	2,0 - 4,5	9,0	7,26-e	15,6	1,5	233 94 060 600
M8	25,0	25,0	21,0	0,5 - 3,0	11,0	5,7-e	19,3	1,5	233 94 080 501
	27,5	27,5	21,0	3,0 - 5,5	11,0	8,7-e	18,8	1,5	233 94 080 502

Depending on the type and volume of your applications, BÖLLHOFF also offers RIVKLE® fasteners with an injected seal under the head.

RIVKLE®

SETTING TOOLS



	Page
General presentation of the RIVKLE® product line	
An optimized assembly solution for improved performance	4
The RIVKLE® technology	6
Setting of RIVKLE® fasteners	7
Material and surface treatment	9
Selection of the nut or stud	10
Additional services	12
Legend	13
The standard RIVKLE® line	
Blind rivet nuts	16
Blind rivet studs	35
RIVKLE® product variants	
HRT nuts - High Resistance Thread	40
SFC nuts and studs - For fiber-reinforced polymer	42
PN nuts - Ultimate pull-out force	44
Seal Ring nuts and studs and other watertight solutions	46
The RIVKLE® setting tools	
Hand operated assembly tools	50
Hydropneumatic and battery-powered setting tools	53
Special installation machines	61
BÖLLHOFF is the only supplier for your assembly components and associated tools	
Part number index	64

RIVKLE® BRK 01 - Manual assembly tool



	Ø RIVKLE®							
	M3	M4	M5	M6	M8	M10	M12	M14
Steel	■	■	■	■				
Stainless steel	■	■	■					
Aluminium	■	■	■	■				

600 g

235 119 00000
Tooling included (M3 - M6)

RIVKLE® BRK01 Kit



235 119 00501	x1
235 119 00502	x1

M3	M4	M5	M6	M8	M10	M4	M5	M6	M8	M10
x50	x50	x50	x50							
						x50	x50	x50		

RIVKLE® M2007 - Manual assembly tool



	Ø RIVKLE®							
	M3	M4	M5	M6	M8	M10	M12	M14
Steel			■	■	■	■	■	
Stainless steel			■	■	■	■	■	
Aluminium			■	■	■	■	■	

1200 g

235 302 01000
Tooling included (M5 - M12)

RIVKLE® M2007 Kit



235 302 01000	x1
235 302 01001	x1
235 302 01002	x1

M5	M6	M8	M10	M12	M6	M8	M10	M6	M8	M10
x1	x1	x1	x1	x1						
	x1	x1	x1					x50	x25	x25
	x1	x1	x1		x50	x25	x25			

	UNC			UNF		
	10-24	1/4-20	5/16-18	10-32	1/4-28	5/16-24
235 302 01003	x1	x1	x1	x1	x1	x1

RIVKLE® BRK 10 - Lever type assembly tool



	Ø RIVKLE®							
	M3	M4	M5	M6	M8	M10	M12	M14
Steel			■	■	■	■		
Stainless steel			■	■	■			
Aluminium			■	■	■	■		

Kg 1900 g **235 120 00000**
Tooling included (M5 - M10)

RIVKLE® ES 51 - Hydraulic manual assembly tool

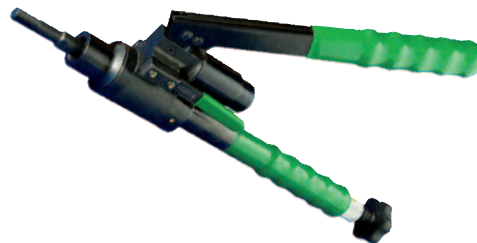

	Ø RIVKLE®							
	M3	M4	M5	M6	M8	M10	M12	M14
Steel				■	■	■	■	■
Stainless steel				■	■	■	■	■
Aluminium				■	■	■	■	■

Kg 2700 g **235 118 00000**
Tooling not included

RIVKLE® OPTEX - Hexagonal punching and assembly tool



	0,5 - 2,5 mm	Ø RIVKLE®		
		M5	M6	M8
Steel		■	■	■
Aluminium		■	■	■

Kg 2100 g **235 110 00000**
Tooling included (M5 - M8)

Tooling equipment



RIVKLE® BRK 01		235 119 XX 001	Ø RIVKLE®			
			M3	M4	M5	M6
Mandrel + Anvil			03	04	05	06



RIVKLE® BRK 10		235 120 XX 001	Ø RIVKLE®			
			M5	M6	M8	M10
Mandrel + Anvil			05	06	08	10



RIVKLE® M2007		235 302 XX 020	Ø RIVKLE®				
			M5	M6	M8	M10	M12
Mandrel			05	06	08	10	12
Anvil		235 302 XX 030	05	06	08	10	12



RIVKLE® ES 51		235 108 XX 020	Ø RIVKLE®				
			M6	M8	M10	M12	M14
Mandrel			06	08	10	12	14
Anvil		235 108 XX 030	06	08	10	12	14
Nut		235 108 00 001	✓	✓	✓	✓	✓



RIVKLE® OPTEX		235 110 XX 020	Ø RIVKLE®		
			M5	M6	M8
Mandrel			05	06	08
Nut		235 110 67 006	✓	✓	✓
Anvil		235 110 XX 030	05	06	08
Punch		235 110 XX 021	05	06	08
Matrix		235 110 XX 031	05	06	08

RIVKLE® – Hydropneumatic and battery-powered setting tools

RIVKLE® P2005



Stroke setting hand tool

	Ø RIVKLE®							
	M3	M4	M5	M6	M8	M10	M12	M14
Steel	■	■	■	■	■	■	■	
Stainless steel	■	■	■	■	■	■		
Aluminium	■	■	■	■	■	■	■	

236 155 01000

Tooling not included (see page 57)

Maximum stroke	7.0 mm
Maximum setting force	26 kN
Operating air pressure	5.5 bar min to 7 max
Weight without tooling	2.6 kg
Noise level	< 70 dB (A)
Production rate	35 RIVKLE® /min

RIVKLE® P2007



A versatile tool, suitable for a wide range of applications

	Ø RIVKLE®							
	M3	M4	M5	M6	M8	M10	M12	M14
Steel		■	■	■	■	■		
Stainless steel	■	■	■	■	■			
Aluminium			■	■	■	■	■	

236 156 01000

Tooling not included (see page 57)

Maximum stroke	7.0 mm
Maximum setting force	21 kN (from M4 to M10 steel)
Operating air pressure	5.5 bar min to 7 max
Weight without tooling	2.2 kg
Noise level	< 70 dB (A)
Production rate	32 RIVKLE® /min

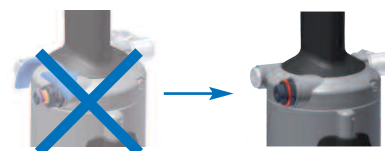

Generic code for a tool with unique force cartridge: **282 520 00 005**.

It is also possible to get mono cartridge alone. Please contact BÖLLHOFF.

RIVKLE® B2007



Maximum stroke	8.0 mm
Maximum setting force	22 kN (from M3 to M10 steel)
Battery	Li-Ion / 14.4 V / 2,6 Ah
Weight without tooling	2.1 kg + 0.3 kg (tooling + battery)
Noise level	< 70 dB (A)
Production rate	24 RIVKLE® /min

A dedicated brochure has been created for this product, please contact BÖLLHOFF.



Battery-powered tool

	Ø RIVKLE®							
	M3	M4	M5	M6	M8	M10	M12	M14
Steel	■	■	■	■	■	■		
Stainless steel	■	■	■	■	■	■		
Aluminium		■	■	■	■	■		

 **Package with 1 battery** 236 166 01000
Package with 2 batteries 236 167 01000

Tooling not included (see page 57)

Comparable weight to the RIVKLE® P2007 when fitted with hose

RIVKLE® B2007	RIVKLE® P2007
	
Tool + Tooling + Battery	Tool + Tooling + Pneumatic
2.12 + 0.07 + 0.30	2.20 + 0.07 + 0.33
Total weight = 2.49 kg	Total weight = 2.60 kg

RIVKLE® P3007



Maximum stroke	8.0 mm
Maximum setting force	40 kN (from M8 to M14 steel)
Operating air pressure	5.5 bar min to 7 max
Weight without tooling	3.4 kg
Noise level	< 70 dB (A)
Production rate	14 RIVKLE® /min

Power

	Ø RIVKLE®							
	M4	M5	M6	M8	M10	M12	M14	M16
Steel				■	■	■	■	
Stainless steel				■	■	■		
Aluminium				■	■	■	■	■

 **236 159 01000**

Tooling not included (see page 57)

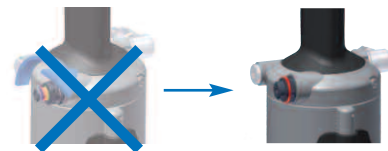

Generic code for a tool with unique force cartridge: **282 520 00 005**.

It is also possible to get mono cartridge alone. Please contact BÖLLHOFF.

RIVKLE® P2007 PN



Ø RIVKLE® PN							
M3	M4	M5	M6	M8	M10	M12	M14
Steel	■	■	■	■			



236 158 01000

Tooling not included (see page 57)

Maximum stroke	14.0 mm
Maximum setting force	14.5 kN
Operating air pressure	5.5 bar min to 7 bar max
Weight without tooling	2.4 kg
Noise level	< 70 dB (A)
Production rate	10 to 15 RIVKLE® /min

RIVKLE® P3007 PN



Ø RIVKLE® PN							
M3	M4	M5	M6	M8	M10	M12	M14
Steel				■	■		



236 160 01000

Tooling not included (see page 57)

Maximum stroke	14.0 mm
Maximum setting force	25 kN
Operating air pressure	5.5 bar min to 7 bar max
Weight without tooling	3.1 kg
Noise level	< 70 dB (A)
Production rate	14 RIVKLE® /min

A dedicated brochure has been created for this product, please contact BÖLLHOFF.

RIVKLE® – Force Controller



The RIVKLE® technology guarantees that each fastener will be properly set during the process.

This non-destructive test is carried out as a background task during the setting process.

This validation of the setting parameters and conditions is available on the hand setting tools and the automatic setting tools as well.

Hand setting tools

The **RIVKLE® FC340 Force Controller** is the most reliable solution to allow you to check that your hand setting tools are correctly adjusted and deliver the suitable setting forces for your application. This controller ensures compliance with the 3rd condition of the RIVKLE® setting parameters.



Digital display

Instant reading of the setting force applied by the tool

Hydraulic pressure sensor

Measurement accuracy: +/-3%

Enclosed hydraulic module

High capacity (-> 40 kN) and repeatability over time

Checking tools

Suitable for the setting of studs and nuts.
Suitable for the setting of M3 to M16 fasteners.

This tool is available with or without calibration certificate.



	282 522 14 000
	282 522 14 800
	282 522 14 900

TOOLING KIT				Ø RIVKLE®									
Washer + Nut				M3	M4	M5	M6	M8	M10	M12	M14	M16	
			282 522 14 1XX	03	04	05	06	08	10	12	14	16	
Washer + Nut				-	M4	M5	D5	M6	D6	M8	D8	M10	
			282 522 14 XXX	-	204	205	505	206	506	208	508	210	

Tooling for RIVKLE® UNC and RIVKLE® UNF available on demand. Select the kit according to the diameter you use.

Tooling



				Ø RIVKLE®										
				M3	M4	M5	M6	M8	M10	M12	M14	M16		
RIVKLE® P2005 / P2007														
Mandrel			236 113 XX 020	03	04	05	06	08	10	*(1)	-	-		
			376 113 XX 020	-	04	05	06	08	*(3)	-	-	-		
Anvil			236 113 XX 030	03	04	05	06	08	10	*(2)	-	-		
			376 113 XX 030	-	04	05	06	08	*(4)	-	-	-		
RIVKLE® P3007														
Mandrel			236 159 XX 020	-	-	-	-	08	10	12	14	16		
Anvil			236 159 XX 030	-	-	-	-	08	10	12	14	16		

				3 → 18 kN					18 → 22 kN		
				M3	M4	M5	M6	M8	M8	M10	
RIVKLE® B2007											
Mandrel			236 113 XX 020	03	04	05	06	08	236 913 08 110	236 913 10 019	
			376 113 XX 020	-	04	05	06	08	-		
Anvil			236 113 XX 030	03	04	05	06	08	08	10	
			376 113 XX 030	-	04	05	06	08	-		
Nose for studs & force >18 kN (M8 & M10)			236 166 00 303						✓	✓	
Fork for studs & force >18 kN (M8 & M10)			236 166 00 304						✓	✓	



				Ø RIVKLE® - UNC					Ø RIVKLE® - UNF			
				4-40	6-32	8-32	10-24	1/4-20	10-32	1/4-28	7/16-20	3/8-24
RIVKLE® P2005 / P2007												
Mandrel			236 113 XX XXX	65 620	67 620	68 620	69 620	74 620	69 720	74 720	78 720	77 720
Anvil			236 113 XX XXX	03 030	67 030	68 030	69 030	74 030	69 030	74 030	*(6)	77 030

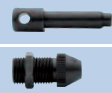

*(1) = 236 153 12 020 *(2) = 236 153 12 030 *(3) = 376 913 10 020 *(4) = 376 913 10 030 *(6) = 236 923 78 030

RIVKLE® – Hydropneumatic and battery-powered setting tools



				Ø RIVKLE® - Fir tree stud	
				D5	D6
RIVKLE® P2005 / P2007			376 913 XX XXX	05 401	*(7)
Mandrel				05 030	06 030
Anvil					

*(7) = 563 500 50 010

				Ø RIVKLE®								
				M3	M4	M5	M6	M8	M10	M12	M14	M16
RIVKLE® P2007 PN			236 913 XX XXX	-	04 094	05 094	06 127	08 101	*(5)	-	-	-
Mandrel				-	04 086	05 095	06 128	08 087	10 010	-	-	-
Anvil												

				Ø RIVKLE®								
				M3	M4	M5	M6	M8	M10	M12	M14	M16
RIVKLE® P3007 PN			236 913 XX XXX	-	-	-	-	08 101	*(5)	-	-	-
Mandrel				-	-	-	-	08 087	10 010	-	-	-
Anvil												

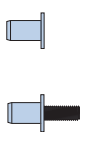
*(5) = 236 913 10 006

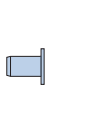
				Ø RIVKLE®								
				M3	M4	M5	M6	M8	M10	M12	M14	M16
RIVKLE® TOOLING BOX			236 113 00 001	✓	✓	✓	✓	✓	✓	✓	-	-
				-	✓	✓	✓	✓	-	-	-	-
			236 113 00 002	✓	✓	✓	✓	✓	-	-	-	-

Accessories

			
Ring			236 803 00 008
Pin			236 803 00 009
Staubli compressed air coupling kit			282 590 10 988 (D6)
			282 590 10 988 (D8)
Staubli hose, length 5 m, with D6 coupling			236 003 01 000



KIT

RIVKLE® P2005	236 155 00 305	236 155 01 001	2 - 3 Kg 282 590 10 820	2,2 - 4 Kg 282 590 10 665	2,2 - 4 Kg 282 590 10 664
RIVKLE® P2007		236 156 01 001			
RIVKLE® P2007 PN	236 156 00 301	-	4 - 6 Kg 282 590 10 152	-	-
RIVKLE® P3007 PN					
RIVKLE® P3007	236 159 00 301	-			

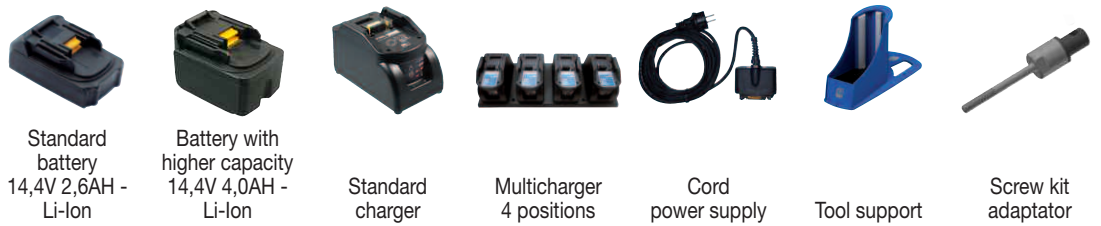

RIVKLE® B2007	282 590 30 350	282 590 30 351	282 590 30 352	282 590 30 354	282 590 30 356	236 166 00 308	See page 60
----------------------	----------------	----------------	----------------	----------------	----------------	----------------	-------------

Refill & purge accessory



RIVKLE® P2007 / P2005		236 114 00 970
RIVKLE® B2007		236 166 00 309



		RIVKLE® P2005	RIVKLE® P2007/P2007PN/P3007PN
	+ 50 mm		282 590 10 984
	+ 100 mm		282 590 10 985
	+ 150 mm		282 590 10 986
	+ 50 mm	282 590 10 789	282 590 10 791
	+ 100 mm	282 590 10 790	282 590 10 792

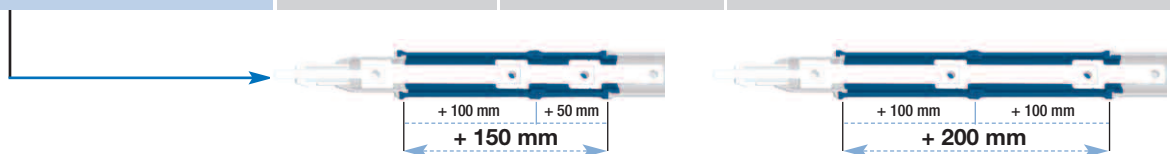



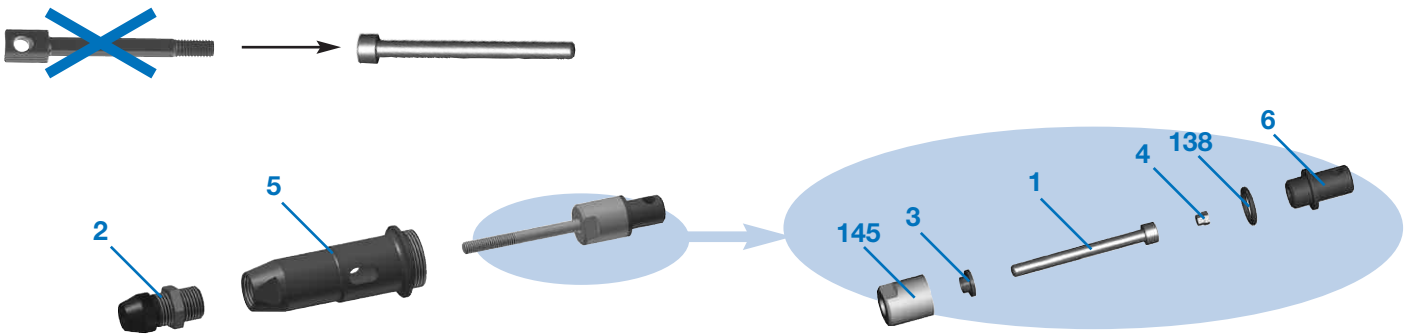

RIVKLE® – Hydropneumatic and battery-powered setting tools

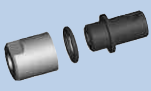
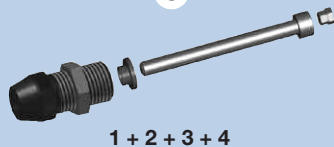

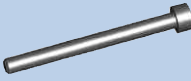
KIT = A + B + C

	A		B		C
	 5 B2007 = original nose		 145 + 138 + 6		 1 + 2 + 3 + 4
	RIVKLE® P2005	RIVKLE® P2007	P2007 + P2005	RIVKLE® B2007	
M3					236 803 03 000
M4					236 803 04 000
M5	236 153 00 043	236 803 00 005	236 803 00 216	236 803 00 216	236 803 05 000
M6					236 803 06 000
M8					236 803 08 000

	 ISO4762 DIN912	 2	 3	 4
M3	M3 x 60 236 803 03 020	236 113 03 030	236 803 03 040	236 803 03 010
M4	M4 x 60 236 803 04 020	236 113 04 030	236 803 04 040	236 803 04 010
M5	M5 x 65 236 803 05 020	236 113 05 030	236 803 05 040	236 803 05 010
M6	M6 x 65 236 803 06 020	236 113 06 030	236 803 06 040	236 803 06 010
M8	M8 x 70 236 803 08 020	236 113 08 030	-	236 803 08 010

RIVKLE® – Special installation machines

**RIVKLE® EPK C / RIVKLE® EPK HP**

Hydraulic pneumatic tool with process control

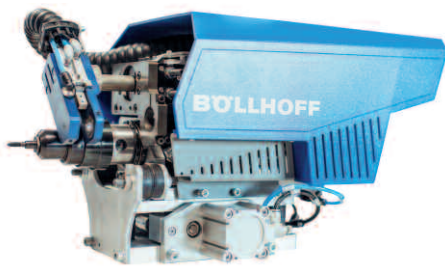
**RIVKLE® Automation**

Setting head with automatic loading system

A dedicated brochure has been created for those products, please contact BÖLLHOFF.

BÖLLHOFF is the only supplier for your assembly components and associated tools





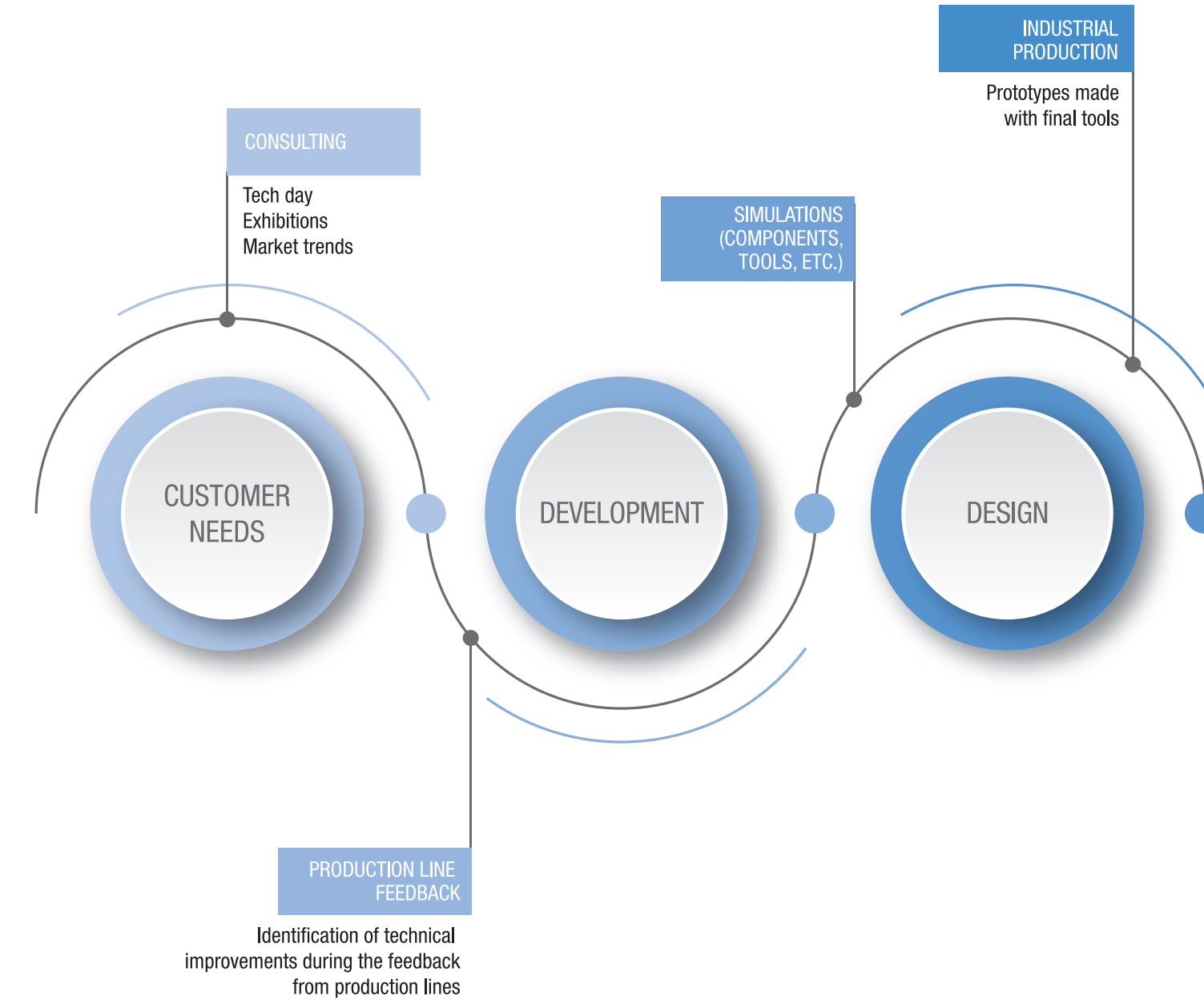

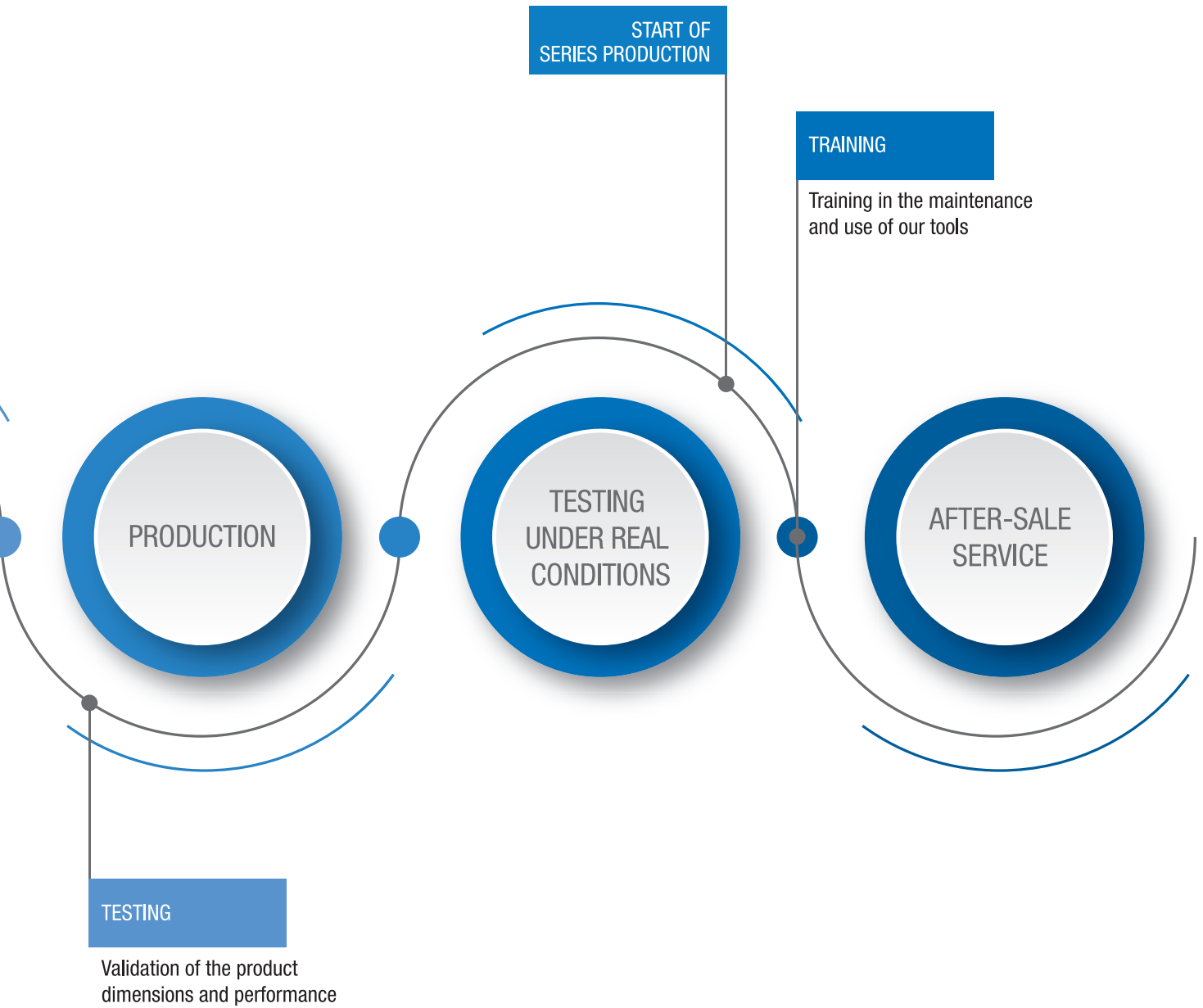
BÖLLHOFF provides you with comprehensive assistance. Thanks to our fully in-house expertise, we will support and guide you, from the stages before your design to the industrial production stage and including to provide you with training in the setting methods.







We have the expertise for each step related to your project: consulting, development, design, prototyping.





RIVKLE® – Part number index

	Page		Page		Page		Page		Page		Page
232 40 060030	41	233 07 030100	20	233 16 080040	29	233 24 080030	32	233 36 050030	29	233 58 040020	26
232 40 080030	41	233 07 030175	20	233 16 080050	29			233 36 050040	29	233 58 040040	26
232 49 080502	41	233 07 030250	20	233 16 080060	29	233 26 030015	28	233 36 060030	29	233 58 050001	26
		233 07 030325	20	233 16 100030	29	233 26 030025	28	233 36 060040	29	233 58 050040	26
232 90 050501	41	233 07 040230	20	233 16 100045	29	233 26 030032	28	233 36 060050	29	233 58 060030	26
		233 07 040325	20	233 16 100060	29	233 26 040015	28	233 36 060060	29	233 58 060045	26
232 91 060502	41	233 07 050040	20	233 16 120030	29	233 26 040030	28	233 36 080030	29	233 58 080001	26
232 91 080504	41	233 07 050230	20	233 16 120045	29	233 26 040035	28	233 36 080040	29	233 58 080055	26
232 91 100503	41	233 07 060230	20	233 16 120060	29	233 26 040042	28	233 36 080050	29	233 58 100035	26
232 91 100501	41	233 07 060255	20			233 26 050015	28	233 36 080060	29	233 58 100055	26
		233 07 100235	20	233 17 030175	21	233 26 050030	28	233 36 100030	29	233 58 120045	26
233 00 030020	33	233 07 100450	20	233 17 030325	21	233 26 060015	28	233 36 100045	29		
233 00 030035	33	233 07 100600	20	233 17 040175	21	233 26 060030	28	233 36 100060	29	233 91 050795	43
233 00 040025	33			233 17 040250	21	233 26 060045	28	233 37 040175	21	233 91 050796	43
233 00 040046	33	233 08 040020	30	233 17 040325	21	233 26 060060	28	233 37 040250	21	233 91 050807	47
233 00 050030	33	233 08 040035	30	233 17 050200	21	233 26 080015	28	233 37 040325	21	233 91 050808	47
233 00 050056	33	233 08 040035	30	233 17 050300	21	233 26 080030	28	233 37 050200	21	233 91 060026	47
233 00 060030	33	233 08 050030	30	233 17 050400	21	233 26 080045	28	233 37 050300	21	233 91 060968	43
233 00 060030	33	233 08 050400	30	233 17 050500	21	233 26 080060	28	233 37 050500	21	233 91 060971	43
233 00 060056	33	233 08 060300	30	233 17 060300	21	233 26 100015	28	233 37 060300	21	233 91 060969	43
233 00 080030	33	233 08 060450	30	233 17 060450	21	233 26 100030	28	233 37 060450	21	233 91 060970	43
233 00 080056	33	233 08 080300	30	233 17 060600	21	233 26 100045	28	233 37 060600	21	233 91 060995	43
233 00 100035	33	233 08 080450	30	233 17 060750	21	233 26 120015	28	233 37 060750	21	233 91 080848	43
233 00 100060	33	233 08 100300	30	233 17 080300	21	233 26 120030	28	233 37 080300	21	233 91 080849	43
		233 08 100450	30	233 17 080450	21	233 26 120045	28	233 37 080450	21	233 91 080875	47
233 01 030010	22	233 08 100600	30	233 17 080600	21	233 26 120060	28	233 37 080750	21	233 91 080876	47
233 01 030015	22			233 17 100300	21			233 37 080750	21		
233 01 030030	22	233 09 050501	28	233 17 100450	21	233 27 040175	20	233 37 100300	21	233 94 050504	47
233 01 030045	22	233 09 060501	28	233 17 100600	21	233 27 040250	20	233 37 100450	21	233 94 050505	47
233 01 030060	22	233 09 080501	28			233 27 040325	20	233 37 100600	21	233 94 060599	47
233 01 040010	22			233 18 040250	30	233 27 050100	20	233 41 040020	17	233 94 060600	47
233 01 040020	22	233 10 030035	34	233 18 040325	30	233 27 050200	20	233 41 050030	17	233 94 080501	47
233 01 040040	22	233 10 030050	34	233 18 050300	30	233 27 050300	20	233 41 050045	17	233 94 080502	47
233 01 040060	22	233 10 040036	34	233 18 050400	30	233 27 050300	20	233 41 050055	17		
233 01 050030	22	233 10 040050	34	233 18 060300	30	233 27 050400	20	233 41 060030	17	233 97 050693	47
233 01 050055	22	233 10 050040	34	233 18 060450	30	233 27 050400	20	233 41 060055	17	233 97 050694	47
233 01 050080	22	233 10 050065	34	233 18 060600	30	233 27 060030	20	233 41 080030	17	233 97 060813	47
233 01 050080	22	233 10 060046	34	233 18 060600	30	233 27 060450	20	233 41 080055	17	233 97 060814	47
233 01 060030	22	233 10 060065	34	233 18 080300	30	233 27 080350	20	233 41 100035	17	233 97 080757	47
233 01 060055	22	233 10 060065	34	233 18 080450	30	233 27 080500	20	233 41 100060	17	233 97 080758	47
233 01 060080	22	233 10 080046	34	233 18 080600	30	233 27 100300	20	233 41 120030	17		
233 01 080030	22	233 10 080065	34	233 18 100300	30			233 41 040230	18	235 10 806020	52
233 01 080055	22	233 10 100046	34	233 18 100450	30	233 30 030035	34	233 41 050230	18	235 10 806030	52
233 01 080080	22	233 10 100065	34	233 18 100600	30	233 30 040050	34	233 41 060230	18	235 10 808020	52
233 01 080105	22					233 30 050045	34	233 41 080230	18	235 10 808030	52
233 01 100035	22	233 11 030015	24	233 20 030020	33	233 30 060045	34	233 44 040020	31	235 10 810020	52
233 01 100060	22	233 11 030030	24	233 20 030035	33	233 30 060065	34	233 44 050030	31	235 10 812020	52
233 01 100085	22	233 11 030045	24	233 20 040030	33	233 30 080045	34	233 44 060030	31	235 10 812030	52
233 01 100110	22	233 11 040020	24	233 20 040045	33	233 30 080065	34	233 44 080030	31	235 10 814020	52
233 01 120040	22	233 11 040030	24	233 20 050031	33	233 30 100045	34			235 10 814030	52
233 01 120070	22	233 11 040050	24	233 20 050055	33			233 48 030023	26		
233 01 120100	22	233 11 040070	24	233 20 060031	33	233 31 030015	24	233 48 030030	26	235 11 000000	51
233 01 140600	22	233 11 050040	24	233 20 060055	33	233 31 030030	24	233 48 040020	26	235 11 005020	52
233 04 040020	32	233 11 050065	24	233 20 080031	33	233 31 040020	24	233 48 040040	26	235 11 005030	52
233 04 050030	32	233 11 050090	24	233 20 080055	33	233 31 040030	24	233 48 050030	26	235 11 005031	52
233 04 060030	32	233 11 060040	24	233 20 100060	33	233 31 040050	24	233 48 050040	26	235 11 006020	52
233 04 080030	32	233 11 060065	24			233 31 040070	24	233 48 060001	26	235 11 006021	52
233 06 030015	28	233 11 060090	24	233 21 030030	23	233 31 050040	24	233 48 060045	26	235 11 006030	52
233 06 030025	28	233 11 080040	24	233 21 040020	23	233 31 050065	24	233 48 080001	26	235 11 006031	52
233 06 030032	28	233 11 080065	24	233 21 040040	23	233 31 060040	24	233 48 080002	26	235 11 006021	52
233 06 040042	28	233 11 080090	24	233 21 040060	23	233 31 060065	24	233 48 100035	26	235 11 008020	52
233 06 040230	28	233 11 100090	24	233 21 050030	23	233 31 050090	24	233 48 100055	26	235 11 008021	52
233 06 050045	28	233 11 100095	24	233 21 050055	23	233 31 060040	24	233 48 120045	26	235 11 008030	52
233 06 050233	28	233 11 120045	24	233 21 050080	23	233 31 060065	24			235 11 008031	52
233 06 060045	28	233 11 120075	24	233 21 060030	23	233 31 080065	24	233 49 050531	26	235 11 067006	52
233 06 060060	28	233 11 120105	24	233 21 060055	23	233 31 080090	24	233 49 060509	26	235 11 800000	51
233 06 060233	28			233 21 060080	23	233 31 100040	24	233 49 080546	26	235 11 900000	50
233 06 080060	28	233 16 030020	29	233 21 080055	23	233 31 100065	24			235 11 900501	50
233 06 080060	28	233 16 030030	29	233 21 080080	23	233 31 100090	24	233 51 040020	17	235 11 900502	50
233 06 080233	28	233 16 030040	29	233 21 080080	23	233 31 120045	24	233 51 050030	17	235 11 903001	52
233 06 080255	28	233 16 040020	29	233 21 080105	23	233 31 120075	24	233 51 060030	17	235 11 904001	52
233 06 100015	28	233 16 040030	29	233 21 100035	23	233 31 120105	24	233 51 060055	17	235 11 905001	52
233 06 100030											

	Page		Page		Page		Page		Page		Page
235 12 010001	52	236 16 601000	54	282 59 030350	59	343 66 030025	27	343 77 080040	19	376 11 304020	57
		236 16 701000	54	282 59 030351	59	343 66 030032	27	343 77 080045	19	376 11 304030	57
235 30 201000	50	236 80 300000	60	282 59 030352	59	343 66 040042	27	343 77 080060	19	376 11 305020	57
235 30 201001	50	236 80 300005	60	282 59 030354	59	343 66 040230	27	343 77 100030	19	376 11 305030	58
235 30 201002	50	236 80 300008	58	282 59 030356	59	343 66 050045	27	343 77 100045	19	376 11 306020	57
235 30 205020	52	236 80 300008	58			343 66 050233	27	343 77 100060	19	376 11 306030	58
235 30 205030	52	236 80 300009	58	343 01 030150	22	343 66 060055	27	343 77 120030	19	376 11 308020	57
235 30 206020	52	236 80 300216	60	343 01 040150	22	343 66 060060	27	343 77 120045	19	376 11 308030	57
235 30 206030	52	236 80 303010	60	343 01 050150	22	343 66 060233	27	343 77 120060	19		
235 30 208020	52	236 80 303020	60	343 01 060200	22	343 66 080060	27			376 91 310020	57
235 30 208030	52	236 80 303040	60	343 01 080450	22	343 66 080233	27	343 98 030590	25	376 91 310030	57
235 30 210020	52	236 80 304000	60			343 66 080255	27	343 98 030591	25	376 91 305401	58
235 30 210030	52	236 80 304010	60	343 08 030150	30	343 66 100015	27	343 98 030592	25		
235 30 212020	52	236 80 304020	60	343 08 040200	30	343 66 100030	27	343 98 030593	25	563 50 050010	56
235 30 212030	52	236 80 304040	60	343 08 050300	30	343 66 100045	27	343 98 040629	25		
		236 80 305000	60	343 08 060300	30	343 66 100060	27	343 98 040630	25	668 30 411038	45
236 00 301000	58	236 80 305010	60	343 08 080300	30	343 66 120015	27	343 98 050629	25	668 30 488038	45
		236 80 305020	60			343 66 120030	27	343 98 050683	25	668 30 511044	45
236 11 300001	58	236 80 305040	60	343 21 040020	18	343 66 120045	27	343 98 060624	25	668 30 511081	45
236 11 300002	58	236 80 306000	60	343 21 050030	18	343 66 120060	27	343 98 060630	25	668 30 588044	45
236 11 303020	57	236 80 306010	60	343 21 060030	18			343 98 060637	25	668 30 588081	45
236 11 303030	57	236 80 306020	60	343 21 080033	18	343 67 030020	19	343 98 060638	25	668 30 611071	45
236 11 304020	57	236 80 306040	60			343 67 030030	19	343 98 080625	25	668 30 611127	45
236 11 304030	57	236 80 308000	60	343 41 030025	16	343 67 040040	19	343 98 080629	25	668 30 688071	45
236 11 305020	57	236 80 308010	60	343 41 040030	16	343 67 040230	19	343 98 080631	25	668 30 688127	45
236 11 305030	57			343 41 040055	16	343 67 050040	19	343 98 100691	25	668 30 811071	45
236 11 306020	57	236 91 304086	58	343 41 050030	16	343 67 050230	19	343 98 100692	25	668 30 888071	45
236 11 306030	57	236 91 304094	58	343 41 050055	16	343 67 060045	19	343 98 100693	25		
236 11 308020	57	236 91 305094	58	343 41 060030	16	343 67 060060	19	343 98 120501	25	668 31 011071	45
236 11 308030	57	236 91 305095	58	343 41 060060	16	343 67 060230	19	343 98 120502	25	668 31 088071	45
236 11 310020	57	236 91 306127	58	343 41 080030	16	343 67 080045	19			668 70 511030	45
236 11 310030	57	236 91 306128	58	343 41 080060	16	343 67 080060	19	372 27 050110	36	668 70 611050	45
236 11 365620	57	236 91 308087	58	343 41 100035	16	343 67 080230	19	372 27 050120	36	668 70 811050	45
236 11 367030	57	236 91 308101	58	343 41 100060	16	343 67 100045	19	372 27 050125	36		
236 11 367620	57	236 91 308110	58	343 41 120040	16	343 67 100060	19	372 27 060115	36		
236 11 368030	57	236 91 310006	58	343 41 120080	16	343 67 100235	19	372 27 060120	36		
236 11 368620	57	236 91 310010	58	343 41 040230	18	343 67 120045	19	372 27 060125	36		
236 11 369030	57	236 91 310019	58	343 41 050230	18	343 67 120060	19	372 27 060125	36		
236 11 369620	57			343 41 060230	18			372 27 080115	36		
236 11 369720	57	236 92 378030	56	343 41 080230	18	343 74 040020	31	372 27 080120	36		
236 11 374030	57					343 74 050030	31	372 27 080125	36		
236 11 374620	57	282 52 000005	53	343 44 040020	31	343 74 060030	31			372 29 060504	36
236 11 374720	57	282 52 214000	56	343 44 050030	31	343 74 080030	31	372 29 080506	36		
236 11 377030	57	282 52 214103	56	343 44 060030	31					372 59 050501	35
236 11 377720	57	282 52 214104	56	343 44 080030	31	343 76 030015	27			372 91 060502	35
236 11 378720	57	282 52 214105	56	343 48 040020	25	343 76 030025	27	372 91 060506	35	372 91 060509	35
236 11 400970	59	282 52 214106	56	343 48 040030	25	343 76 030032	27	372 91 060517	35	372 91 060522	43
		282 52 214108	56	343 48 040030	25	343 76 040030	27	372 91 060525	43	372 91 080502	35
236 15 300043	60	282 52 214110	56	343 48 050020	25	343 76 040035	27	372 91 080507	35	372 91 080510	35
236 15 312020	56	282 52 214112	56	343 48 050025	25	343 76 040042	27			372 97 059505	36
236 15 312030	56	282 52 214114	56	343 48 060055	25	343 76 040047	27	372 97 059507	36	372 97 059508	36
236 15 500305	59	282 52 214116	55	343 48 080030	25	343 76 050020	27	372 97 060518	35	372 97 060519	35
236 15 501000	53	282 52 214204	56	343 48 100035	25	343 76 050030	27	372 97 060537	47	372 97 060537	47
236 15 501001	59	282 52 214205	56	343 49 040506	25	343 76 050045	27	372 97 069501	36	372 97 069502	36
236 15 600301	59	282 52 214206	56	343 49 040507	25	343 76 060015	27	372 97 069503	36	372 97 069504	36
236 15 601000	53	282 52 214208	56	343 49 050538	25	343 76 060030	27	372 97 069505	36	372 97 069506	36
236 15 601001	59	282 52 214210	56	343 49 100501	25	343 76 060045	27	372 97 069507	36	372 97 069507	36
236 15 700301	57	282 52 214505	56			343 76 060060	27	372 97 080505	35	372 97 080507	35
236 15 700309	58	282 52 214506	56	343 51 040030	16	343 76 080015	27	372 97 080510	35		
236 15 701001	57	282 52 214508	56	343 51 050030	16	343 76 080030	27			372 98 050502	37
236 15 801000	55	282 52 214800	56	343 51 060030	16	343 76 080045	27	372 98 050503	37	372 98 050504	37
236 15 900301	59	282 52 214900	56	343 51 060055	16	343 76 080060	27	372 98 060506	37	372 98 060507	37
236 15 901000	54	282 52 215000	56	343 51 080030	16	343 76 100015	27	372 98 060507	37	372 98 060508	37
236 15 901001	57	282 52 216000	56	343 51 080060	16	343 76 100030	27				
236 15 908020	57	282 52 217000	56	343 51 100060	16	343 76 100045	27				
236 15 908030	57	282 52 218000	56			343 76 100060	27				
236 15 910020	57	282 52 219000	56	343 58 040025	25	343 76 120030	27				
236 15 910030	57			343 58 050020	25	343 76 120045	27				
236 15 912020	57	282 59 010152	59	343 58 060030	25	343 76 120060	27				
236 15 912030	57	282 59 010664	59	343 58 060055	25			343 77 030015	19		
236 15 914020	57	282 59 010665	59					343 77 030030	19		
236 15 914030	57	282 59 010789	59	343 59 040505	24			343 77 040030	19		
236 15 916020	57	282 59 010790	59	343 59 050505	24			343 77 040040	19		
236 15 916030	57	282 59 010791	59					343 77 050040	19		
		282 59 010820	59	343 64 050030	31			343 77 050030	19		
236 16 001000	55	282 59 010984	59	343 64 060030	31			343 77 060031	19		
236 16 600303	57										

BÖLLHOFF



Böllhoff Group

Innovative partner for joining technology with assembly and logistics solutions.

Find your local partner at www.boellhoff.com or contact us at fat@boellhoff.com.

Passion for successful joining.